



CHAPTER OVERVIEW

Operating Instructions

.....

.....

.....

Attachment

A

B

C

D

E

Manufacturer in terms of 97/23/EC

The full name and address of the manufacturer is:

Lenhardt & Wagner GmbH

An der Tuchbleiche 39

68623 Hüttenfeld / Germany

Phone: +49 (0) 62 56 - 85 88 0 - 0

Fax: +49 (0) 62 56 - 85 88 0 - 14

E-Mail: service@lw-compressors.com

Internet: www.lw-compressors.com





SERVICE INFORMATION / WARRANTY

Compressor information

Type designation

Serial number

Date of construction

Purchase information

Purchase date

First commissioned on

Warranty period

Dealer's stamp

Warranty

L&W will uphold warranty claims made during a period of 12 months from the invoice date.

If the compressor was purchased from an official L&W dealer, the date on the dealer's invoice is valid. Warranty claims can only be made on presentation of the original invoice.

Should verifiably defective parts have been delivered, we will decide to either replace the parts or repair them. The resulting transport and assembly costs will be invoiced.

No reduction of the purchase price or changes to the contract can be made. The parts for which a claim is being made should be kept safe by the purchaser and, when requested, sent to us at their cost. Replaced parts become the property of L&W. If maintenance work is carried out without our knowledge or permission by the purchaser or a third party, we are absolved from any liability for warranty claims. As a matter of principle, warranty claims can only be made by the initial purchaser.

Operating Instructions

Breathing Air Compressor

LW SC-180 ES / LW SC-250 ES





TABLE OF CONTENTS

General Information and Technical Data

General Information / Description of Warning Symbols	4
Scope of Delivery	5
Technical Data	6
Unit Assembly	7
Switchboard	8
Flow chart	9

Safety Precautions

Intended Use / Operators	11
Safety instructions on the unit	12
General Safety Precautions	13
Unit customised safety notices	14
Maintenance instructions	15
Transportation instructions / Safety regulations	16

Installation

Installation in closed rooms	18
Dimensions	19
Minimum distances	20
Ventilation	21
Electrical Installation	22 - 23

Operation

Important operation instructions	25
First commissioning	26 - 28
Daily commissioning	29
Filling procedure	30
Switch off the compressor	31

Remedying faults	32 - 36
-------------------------------	---------

Maintenance and Service

Service, Repair and Maintenance	38
Maintenance Lists / Maintenance Intervals	39 - 42
Check V-belt tension / Tension V-belt.....	43
Compressor lubrication / Check oil level	44
Oil change	45
Final pressure switch	46
Automatic condensation dump system	47

A



TABLE OF CONTENTS

Wartung und Instandhaltung - Fortsetzung

Oil / Water separators 2nd stage - maintenance	48
Filter housing / Filter cartridge	49
Filter cartridge change	50
Filter housing - Maintenance	51
Pneumatic condensate valve - maintenance	52
Inlet filters / Inlet filter cartridge change	53
Cylinder heads and valves	54
Replace inlet and outlet valve 1st stage	55 - 56
Replace inlet and outlet valves 2nd and 3rd stage	57
Safety valves	58
Pressure maintaining / non return valve	59
Safety valve test	60
Leak test	61
Pressure gas vessel test	62
Maintenance records	64 - 68

Storage

Conservation / storage of the compressor.....	69
De-conservation, commissioning	69
Transportation instructions / Disposal	70

A

GENERAL INFORMATION

General Information

We strongly recommend reading this manual thoroughly prior to operation and follow all the safety precautions precisely. Damage resulting from any deviation from these instructions is excluded from warranty and liability for this product. Carry out other commissioning steps only if you have fully understood the following contents.

Before commissioning and using the unit, carry out all the essential preliminary work and measures concerning legal regulations and safety. These are described on the following pages of this operation manual.

A

Description of marks and warning signs

The following warning signs are used in this document to identify the corresponding warning notes which require particular attention by the user. The warning signs are defined as follows:



Caution

Indicates an imminently hazardous situation which, if not avoided, could result in serious injury, physical injury or death.



Warning

Indicates a potentially hazardous situation which, if not avoided, could result in physical injury or damage to the product or environment.



Note

Indicates additional information on how to use the unit.



DESCRIPTION

Scope of Delivery

Compressors are provided in different equipped versions.

Versions

Filling pressure versions:

- PN 225 bar
- PN 330 bar
- PN 225 / 330 bar

Specifications

- Elektro motor
- Powder coated steel housing (RAL 7016)
- Sound insulated housing
- Automatic condensate drain
- Automatic stop at final pressure
- Hour counter
- Main-, Start/ Stop– and condensate test buttons, as well as emergency stop switch
- 2x Filling hose c/w filling valve
- Safety switch
- Pressure maintaining and non return valve
- All pistons c/w steel piston rings
- Oil- / Water separators after 2nd and 3rd stage
- Safety valves after each stage
- 3 x concentric suction/pressure valves
- Maintenance door on both sides
- Filling pressure to your choice (200 or 300 bar)
- Connections to your choice (DIN 200 bar or 300 bar, CGA 200 bar or 300 bar and INT)
- Breathing air purification an accordance to EN 12021

Options

- Auto start system
- Up to 2 additional filling hoses available
- 200 and 300 bar parallel filling pressures
- Phase monitoring c/w shut down at wrong direction of rotation
- Indicator light - service interval
- Ambient temperature monitoring
- Motor protection switch
- Oil pressure gauge
- Intermediate pressure gauges
- Oil pressure monitoring c/w auto shut down
- Low pressure oil pump and filter
- Cylinder head temperature monitoring with auto shut down
- Oil temperature display with auto shut down
- 1.7l filter housing
- Puracon filter monitoring (Auto shut down also available)
- Remote Tab Control - RTC
- Additional high pressure outlet
- CEE plug
- Special voltages / frequencies on request

DESCRIPTION

Technical Data



A

Technical Data	LW SC-180 ES	LW SC-250 ES
Capacity [l/min]:	150	200
Max. Operating Pressure [bar]:	350	350
RPM [min ⁻¹]:	1505	1710
Number of Pressure Stages:	3	3
Cylinder Bore 1st Stage [mm]:	Ø 72	Ø 75,5
Cylinder Bore 2nd Stage [mm]:	Ø 32	Ø 32
Cylinder Bore 3rd Stage [mm]:	Ø 14	Ø 14
Medium:	Compressed Air / Breathing Air	
Intake Pressure:	atmospheric	
Oil Pressure [bar]:	+2 +/-0,4	+2 +/-0,4
Oil Capacity [l]:	0,8	0,8
Intake Temperature [°C]:	0 < +45	0 < +45
Ambient Temperature [°C]:	+5 < +45	+5 < +45
Cooling Air Volume [m ³ /h]:	> 1200 / > 1440	> 1650 / > 1980
Voltage:	E-Motor 230 - 440V / 3-Phases / 50-60 Hz	E-Motor 230 - 440V / 3-Phases / 50-60 Hz
Protection Class Drive Motor:	IP 54	IP 54
Drive Power [kw] 50 Hz / 60 Hz:	4,0 / 4,8	5,5 / 6,6
RPM Motor [min ⁻¹]:	2890	2890
Start:	Stern / Dreieck	
Noise level from a distance of 1 m [dB(A)]:	61	61
Dimensions W x D x H [mm]:	900 x 1085 x 1330	
Weight [kg]:	ca. 263	ca. 265
Content Volume Filter housing [l]:	0,69	0,69

DESCRIPTION

Unit Assembly

A



No.	Designation
1	Switchboard
2	Filling pressure gauge (200 bar)
3	Filling valve (200 bar) c/w Filling Hose
4	Filling pressure gauge (300 bar)
5	Filling valve (300 bar) c/w Filling Hose
6	Filter Housing

DESCRIPTION

Switchboard

A



No.	Designation
1	Emergency shut-off switch
2	Hour counter
3	ON button
4	OFF button
5	Drain test button

DESCRIPTION

Flow chart

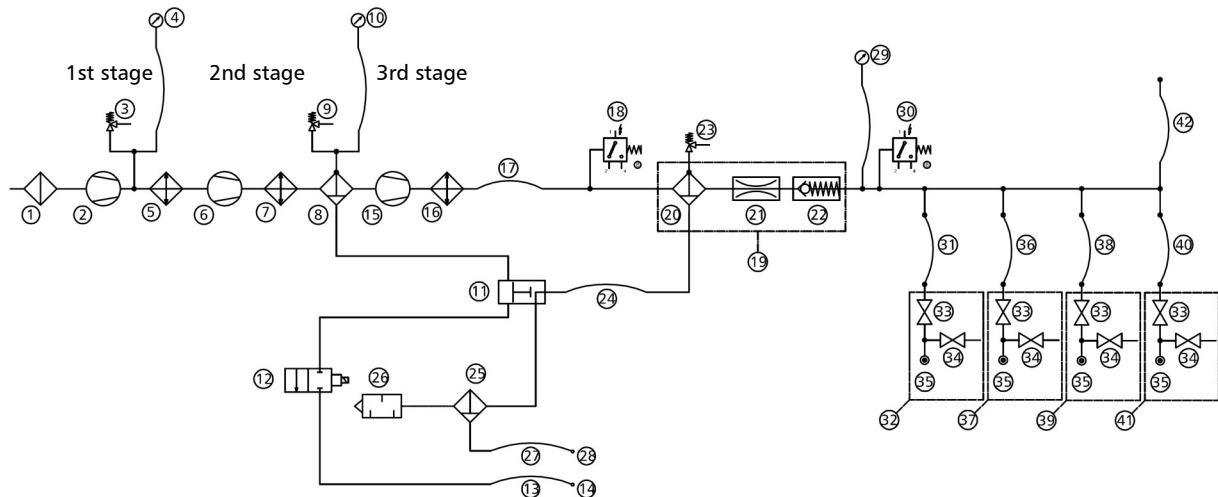

- | | |
|--|---|
| 1. Ansaugfilter / Air Intake Filter | 23. Sicherheitsventil 3. Stufe / Safety Valve 3rd Stage |
| 2. 1. Verdichterstufe / 1st Pressure Stage | 24. Hochdruckschlauch / HP-Hose |
| 3. Sicherheitsventil 1. Stufe / Safety Valve 1st Stage | 25. Öl-/Wasserabscheider / Oil/Water Separator |
| 4. Zwischendruckmanometer (Option) / Interstage Pressure Gauge (Option) | 26. Schalldämpfer / Silencer |
| 5. Wärmetauscher / Heat Exchanger | 27. Kondensatablassschlauch / Condensate Drain Hose |
| 6. 2. Verdichterstufe / 2nd Pressure Stage | 28. Schottverschraubung 8L / Bulkhead Fitting 8L |
| 7. Wärmetauscher / Heat Exchanger | 29. Manometer / Gauge |
| 8. Öl-/Wasserabscheider / Oil/Water Separator | 30. Druckschalter „Auto Start“ (Option) / Pressure Switch „Auto Start“ (Option) |
| 9. Sicherheitsventil 2. Stufe / Safety Valve 2nd Stage | 31. Füllschlauch / Filling Hose |
| 10. Zwischendruckmanometer (Option) / Interstage Pressure Gauge (Option) | 32. Kreuzventil / Filling Valve „Cross Design“ |
| 11. Pneum. Kondensatventil / Pneumatic Condensate Valve | 33. Füllspindel / Filling spindle |
| 12. Magnetventil / Solenoid Valve | 34. Entlüftungsspindel / Vent spindle |
| 13. Kondensatablassschlauch / Condensate Drain Hose | 35. Flaschenanschluss Flaschenanschluss nach Wahl (DIN 200 oder 300bar, CGA 200bar oder 300bar und INT) / Tank connector (DIN 200bar or 300bar, CGA 200bar or 300bar and INT) |
| 14. Schottverschraubung 8L / Bulkhead Fitting 8L | 36. Füllschlauch / Filling Hose |
| 15. 3. Verdichterstufe / 3rd Pressure Stage | 37. Kreuzventil / Filling Valve „Cross Design“ |
| 16. Wärmetauscher / Heat Exchanger | 38. Füllschlauch (Option) / Filling Hose (Option) |
| 17. Hochdruckschlauch / HP-Hose | 39. Kreuzventil (Option) / Filling Valve „Cross Design“ (Option) |
| 18. Druckschalter „Auto Stopp“ / Pressure Switch „Auto Stop“ | 40. Füllschlauch (Option) / Filling Hose (Option) |
| 19. Filtergehäuse 0,69 l / Filter Housing 0.69 ltr. | 41. Kreuzventil (Option) / Filling Valve „Cross Design“ (Option) |
| 20. Öl-/Wasserabscheider / Oil/Water Separator | 42. Hochdruckschlauch (Option) / HP-Hose (Option) |
| 21. Druckhalteventil / Pressure Maintaining Valve | |
| 22. Rückschlagventil / Non-Return Valve | |



A

SICHERHEITSHINWEISE



SAFETY PRECAUTIONS

A

Intended Use

Only use the unit in perfect condition for its intended purpose, safety and intended use and observe the operating instructions! In particular disorders that may affect safety have to be eliminated immediately!

Use the unit exclusively for the determined medium (see "Technical Data"). Any other use that is not specified is not authorized. The manufacturer/supplier shall not be liable for any damages resulting from such use. Such risk lies entirely with the user. Authorization for use is also under the condition that the instruction manual is complied with and inspection and maintenance requirements are enforced.

No change and modification to the unit can be made without the written agreement of the manufacturer. The manufacturer is not liable for damage to persons or property resulting from unauthorised modifications.

Operators

Target groups in these instructions;

Operators

Operators are persons who are authorized and briefed for the use of the compressor.

Qualified personnel

Qualified personnel are persons who are entitled to repair, service, modify and maintain the system.



Warning

Only trained personnel are permitted to work on the unit!



Warning

Work on the electrical equipment on / with the machine / unit may only be carried out by qualified electricians.

SAFETY PRECAUTIONS

Safety instructions on the unit

Importance of notes and warning signs that are affixed to the compressor according to the application or its equipment.

A



Warning
High voltage!



Note
Ensure correct direction of rotation!



SAFETY PRECAUTIONS

General Safety Precautions

- Read the Operating Instructions of this product carefully prior to use.
- Strictly follow the instructions. The user must fully understand and strictly observe the instructions. Use the product only for the purposes specified in the intended use section of this document.
- Do not dispose the operating instructions. Ensure that they are retained and appropriately used by the product user.
- Only trained and competent personnel are permitted to use this product.
- Comply with all local and national rules and regulations associated with this product.
- Only trained and competent personnel are permitted to inspect, repair and service the product.
- Only authentic L&W parts and accessories may be used for maintenance work. Otherwise, the proper functioning of the product may be impaired.
- Do not use faulty or incomplete products. Do not modify the product.
- Inform L&W in the event of any product or component fault or failure.
- The quality of the air supply must meet EN 12021 specifications for breathing air.
- Do not use the product in areas prone to explosion or in the presence of flammable gases. The product is not designed for these applications. An explosion might be the result if certain conditions apply.

A



SAFETY PRECAUTIONS

Unit customised safety notices

Organisational measures

- In addition to the instruction manual, observe and comply with universally valid legal and other obligatory regulations regarding accident prevention and environment protection.
- In addition to the instruction manual, provide supplementary instructions for supervision and monitoring duties taking into consideration exceptional factors e.g. with regard to organisation of work, production, personnel employed.
- Supervise personnel's work in accordance with the instruction manual, taking into account safety and danger factors.
- Observe all safety and danger notices on the compressor and check readability and completeness.

Safety instructions operation

- Take measures to ensure that the machine is only taken into operation under safe and functional conditions. Only operate the compressor if all protective and safety equipment, e.g. detachable protective equipment, are provided and in good working order.
- Check the compressor at least once per day for obvious damage and defects. Inform the responsible department / person immediately if anything is not as it should be (including operation performance). Shut down the machine immediately if necessary and lock it.
- In case of malfunction, stop the compressor immediately and lock it. Repair malfunctions immediately.
- If there is a failure in the electric energy supply, shut the machine / unit down immediately.
- Ensure safe and environmentally friendly disposal of consumables and old parts.
- The stipulated hearing protectors must be worn.
- Soundproofing equipment on the compressor has to be activated in safety function during operation.
- When handling with fats, oils and other chemical agents, observe the note for the product-related safety.

A

SAFETY PRECAUTIONS

Maintenance instructions

- Hoses have to be checked by the operator (pressure and visual inspection) at reasonable intervals, even if no safety-related defects have been detected.
- Immediately repair any damage. Escaping compressed air can cause injury.
- Depressurise system and pressure lines before beginning repair work.
- Pressurised air lines must be laid and mounted by qualified personnel. Connections must not be mixed up. Fittings, length and quality of the piping must correspond to requirements.
- Adjustment, maintenance and inspection activities and keep appointments, including information on replacement parts / equipment, prescribed in the operating instructions have to be respected.
- If the machine / equipment is completely off during maintenance and repair work, it must be protected against unexpected restart. Turn off main control device and remove the key and/or display a warning sign on the main switch.
- The machine and especially the connections and fittings should be cleaned from oil, fuel and maintenance products at the beginning of the maintenance / repair. Do not use aggressive cleaning agents. Use fibre-free cleaning cloths.
- Switch off compressor and clean with a slightly damp cloth. Remove dirt from cooling pipes by using a brush.
- After cleaning, examine all pipes for leaks, loose connections, chafing and damage. Immediately eliminate any faults.
- Always retighten any screw connections loosened for maintenance or repair work.
- If it is necessary to remove safety devices for maintenance and repair work, these must be replaced and checked immediately after completion of the maintenance or repair work.
- The electrical equipment of the compressor must be regularly checked. Defects, such as loose screw connections or burnt wires, must be immediately rectified by electrically skilled personnel.
- Only personnel with particular knowledge and experience with pneumatics may carry out work on pneumatic equipment.
- Only personnel with particular knowledge and experience in gas equipment may carry out work on gas equipment.



SAFETY PRECAUTIONS

Transportation instructions

- Parts which need to be dismantled for transport purposes must be carefully replaced and secured before taking into operation.
- The transport may only be carried out by trained personnel.
- For transportation, only use lifting devices and equipment with sufficient lifting power.
- Do not stand or work under suspended loads.
- Also separate from minor relocation machinery / system of any external energy supply. Before recommissioning, reconnect the machine to the mains according to regulations.
- When recommissioning, proceed according to the operating instructions..

Safety regulations

- Inspections according to legal and local obligatory regulations regarding accident prevention are carried out by the manufacturer or by authorised expert personnel. No guarantees whatsoever are valid for damage caused or favoured by the non-consideration of these directions for use.

A



A

INSTALLATION

INSTALLATION

Installation in closed rooms



Danger

No operation in explosion-hazard areas.

The unit is not approved for operation in areas prone to explosion.

For installation in closed rooms, observe the following:

- Install the unit horizontally and level. The floor must be vibration-free and capable of taking the load of the system weight.
- The compressor room must be clean, dry, dust free and as cool as possible. Avoid direct exposure to sunlight. If possible, install unit in such a manner that the compressor fan can intake fresh air from outside. Ensure adequate ventilation and exhaust air opening.
- When locating the compressor in rooms of less than 30 m³ space where natural ventilation is not ensured or other systems having high radiation are operating in the same room, measures must be taken to provide artificial ventilation.
- Intake air must be free from noxious gas e.g. smoke, solvent vapours, exhaust fumes etc.
- Observe the specified operating temperature (see "Technical Data")!



Hinweis

- Intake air must be free from noxious gas e.g. smoke, solvent vapours and exhaust fumes. We recommend not to use the intake air inside the compressor housing. An intake hose would be recommendable!

Approximate value - Diameter of intake hose depending on the length of the intake hose

Pos.	Length of Intake Hose [m]	Diameter of Intake Hose [mm]
1	≤ 03	Ø 30
2	≤ 10	Ø 80
3	≤ 15	Ø 100
4	≤ 20	Ø 120

INSTALLATION

Dimensions

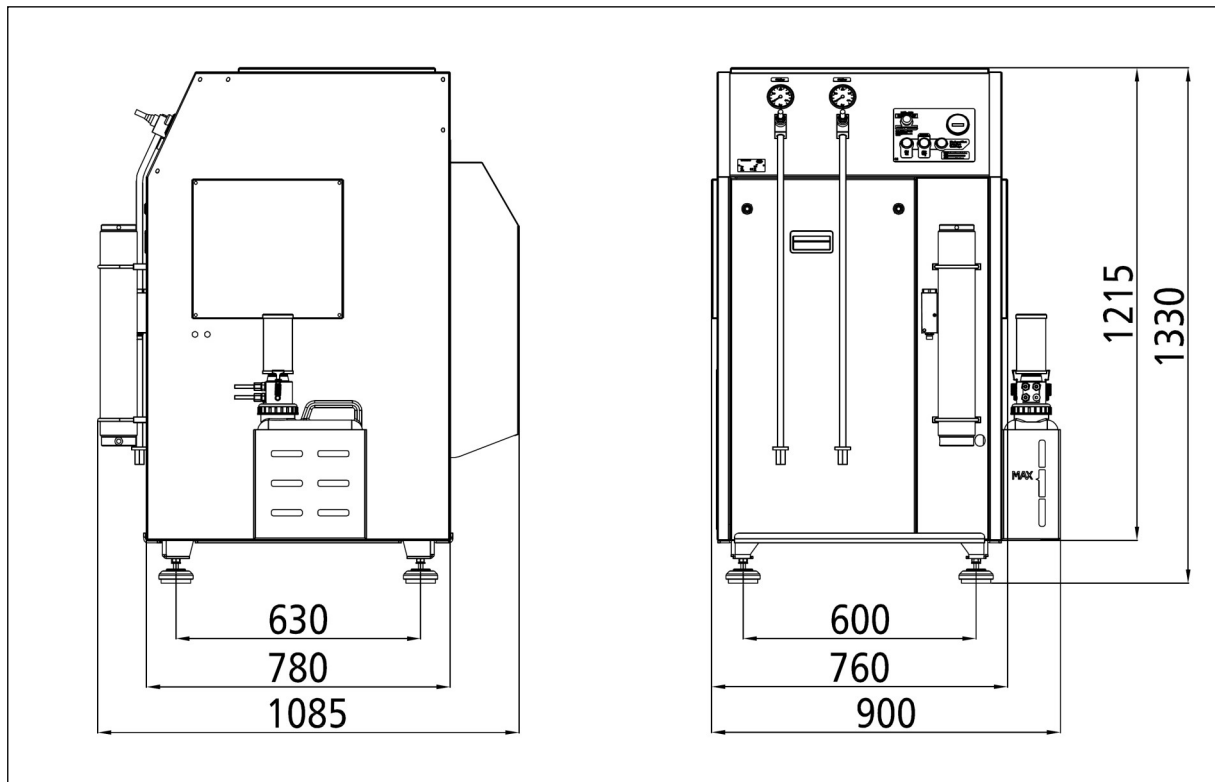

A

Fig. Dimensions

INSTALLATION

Minimum distances



Note

Minimum distances must be adhered!

- Make sure that the compressor always has a sufficient amount of fresh air available.
- To prevent serious damage, ensure that the cooling air flow can flow freely.
- The following minimum distances must be adhered:
Front side min. 1500 mm, sides min. 500 mm, rear side min. 500 mm.
Avoid anything in this area which can restrict the cooling air flow.

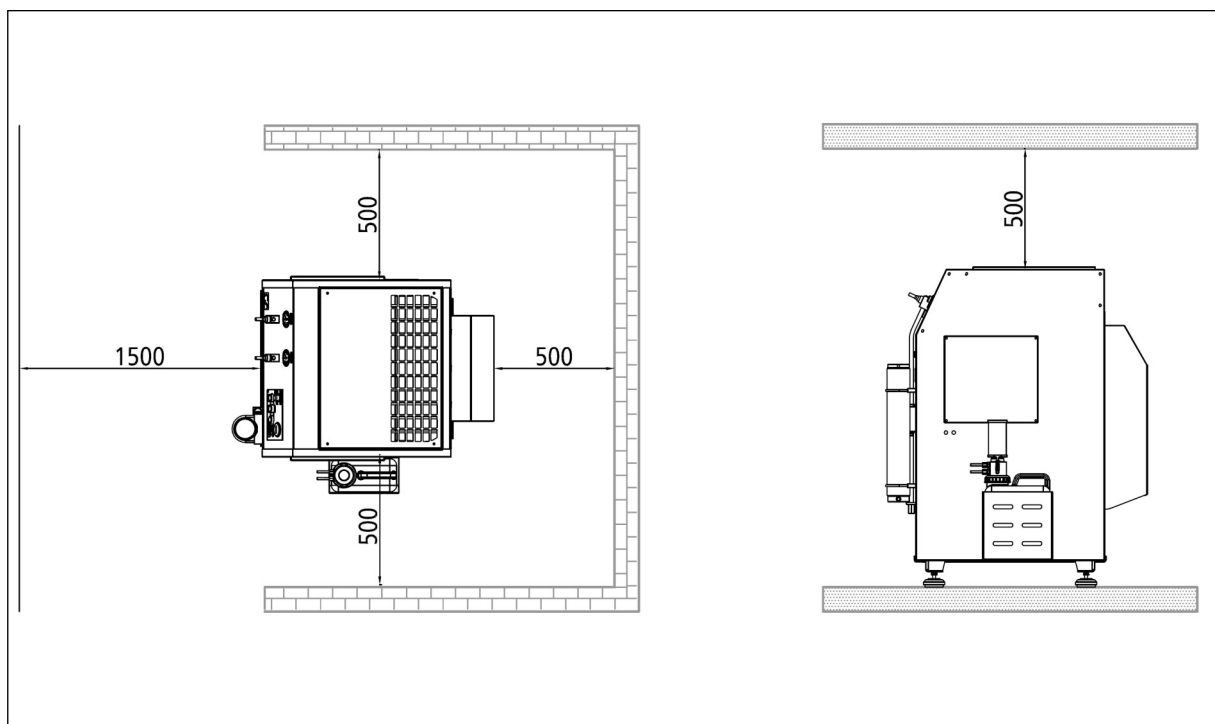

Fig. Minimum distances

INSTALLATION

Ventilation

- Make sure that the compressor always has a sufficient amount of fresh air available for cooling.
- To prevent serious damage, ensure that the cooling air flow can flow freely.
- The necessary cooling air flow can be calculated by using the following formula:
 $300 \times \text{drive power [kW]} = \text{required cooling air flow [m}^3/\text{h]}$
 Example 11kW motor: $300 \times 11\text{kW} = 3300 \text{ m}^3/\text{h} = \text{required cooling air flow.}$
- The fan capacity for fresh air and warm air must meet at least the required cooling air flow. The fans must have the same capacity.

A

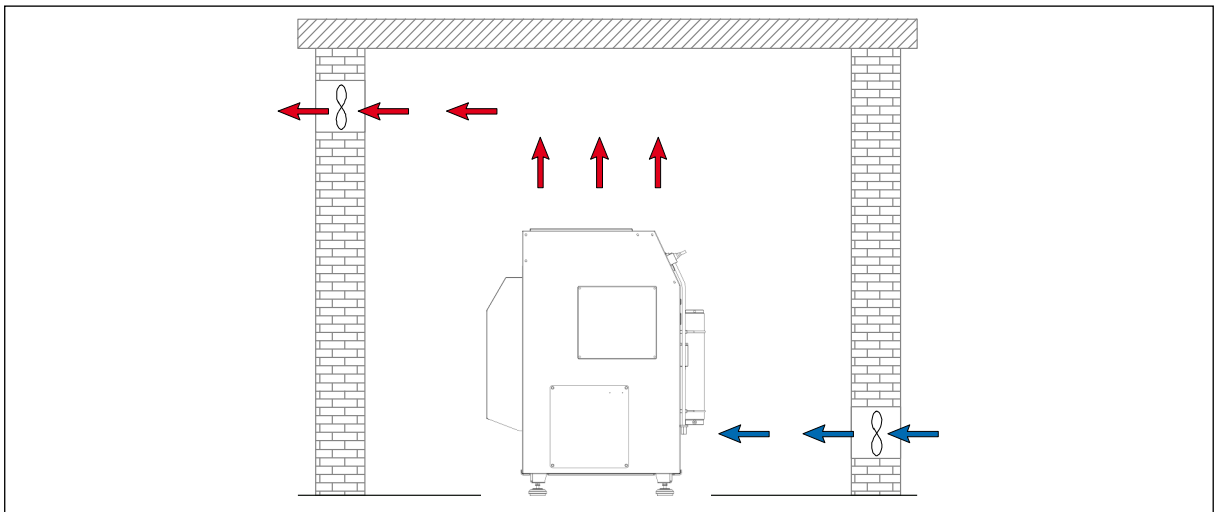

Fig. Ventilation through facade

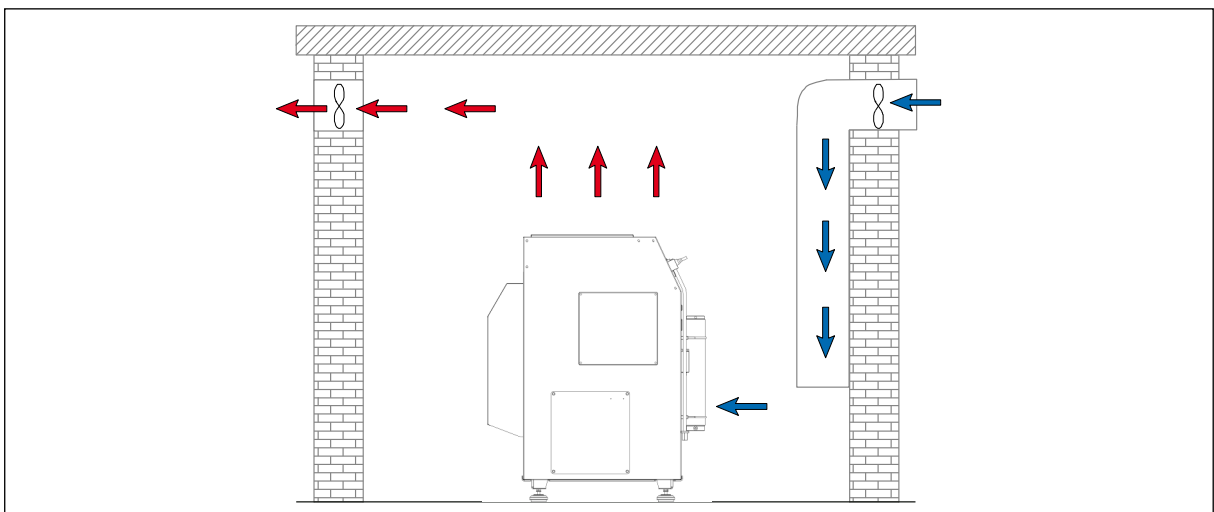

Fig. Ventilation via ventilation stack

INSTALLATION

Electrical Installation



Warning

Work on the electrical equipment on / with the machine / unit may only be carried out by qualified electricians.

For installation of electrical equipment, observe the following:

- If control devices are delivered by the factory, refer to the appropriate wiring diagram.
- Ensure correct installation of protective conductors.
- Check conformity of motor and control device tension and frequency with those of the electric network (see name plate on the compressor).
- The fusing should be done in accordance with the valid regulations of the responsible electricity supply company.
- When connecting the unit to the electrical supply, check the compressor direction of rotation (see chapter "Maintenance" -> Check turning direction).
- Fuse the motor correctly (see table; use slow-blow fuses).

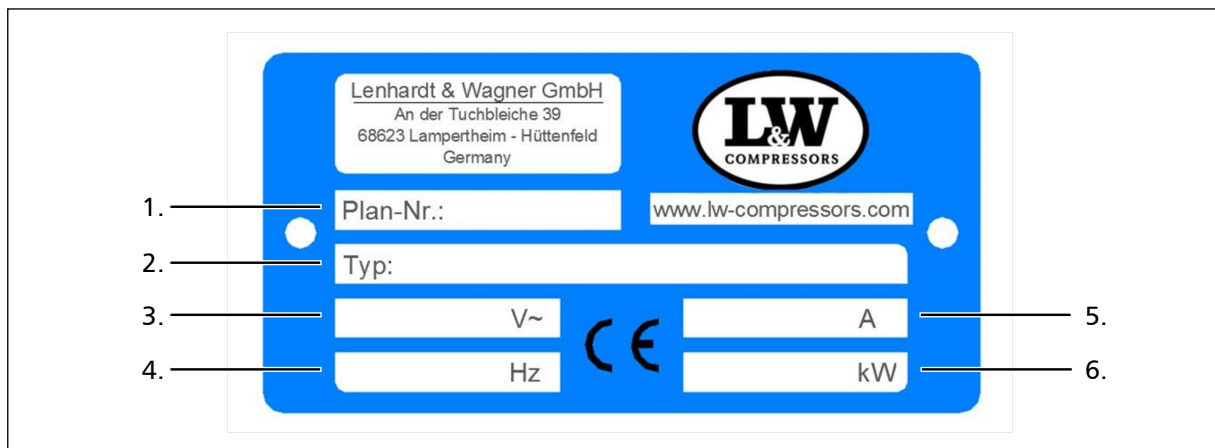

Fig. Compressor name plate

No.	Designation
1.	Circuit diagram number
2.	Compressor type
3.	Power supply
4.	Frequency
5.	Motor current consumption
6.	Nominal motor power

INSTALLATION

Electrical Installation

The standard compressor version is prepared for the connection to three phases (brown, black, grey), neutral conductor (blue) and protective earth conductor (green/yellow).

Fig. - Connection to the switch box

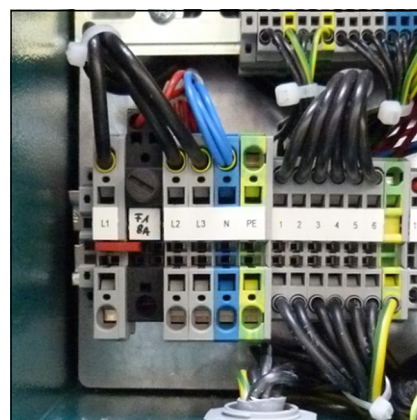

A

Recommended fuses for 360 - 500 V operating voltage

Nominal motor power		Fusing start A		Connection in mm ²	
[kw]	[A]	Direct	Star/Delta	Contactor supply	Motor S/D
2.2	5	10	-	1.5	1.5
4	8.5	20	-	2.5	1.5
5.5	11.3	25	20	2.5	1.5
7.5	15.2	30	25	2.5	1.5
11	21.7	-	35	4	2.5
15	29.9	-	35	6	4
18.5	36	-	50	6	4
22	41	-	50	10	4
30	55	-	63	10	6

Recommended fuses for 220 - 240 V operating voltage

Nominal motor power		Fusing start A		Connection in mm ²	
[kw]	[A]	Direct	Star/Delta	Contactor supply	Motor S/D
2.2	8.7	20	-	1.5	1.5
4	14.8	25	-	2.5	1.5
5.5	19.6	35	25	4	2.5
7.5	26.4	50	35	6	4
11	38	-	50	6	4
15	51	-	63	10	4
18.5	63	-	80	16	6
22	71	-	80	16	6
30	96	-	125	25	10



A

OPERATION

OPERATION

Important operation instructions



Note

Ensure that all persons handling the compressor are familiar with function and operation of the unit.



Wear hearing protection

When working on a running machine, always wear hearing protection.

A

FIRST COMMISSIONING

A

Prior to first commissioning, observe the following:

Necessary steps are described on the next page.

- Ensure that cooling air can flow freely.
- Check compressor oil level with the oil dipstick (see next page).
- Check all connections and retighten if necessary.
- Check if the filter cartridge is in place (see "Service and Maintenance").
- Check the V-belt tension (see next page).
- Check if all filling valves are closed. Open one filling valve and hold tight manually!

Start the compressor

1. Start the compressor by pushing the ON button.
2. Check turning direction - see the rotary direction arrow on the housing of the electric motor (see next pages). If the turning direction is wrong, immediately stop the compressor by pushing the OFF button and contact an authorised electrician.



Warning

Wrong impeller rotation direction!

Immediately after switching the compressor on, check the rotation direction. Depending on the place of installation, the phase sequence can influence the rotation direction.

3. Check oil pressure (if oil pressure gauge is installed).
4. Run the compressor for about 2 minutes.
5. Close the open filling valve carefully.
6. Run the compressor up to maximum pressure and check if the final pressure switch shuts off the compressor. If the final pressure switch does not shut off, switch off the compressor with the OFF button (see chapter "REMEDYING FAULTS").
7. Check the compressor unit for leaks (see "SERVICE AND MAINTENANCE")
8. Now check the condensate drain valves:
 - Fix the black condensate hoses
 - Drain test - press the test button
 - If correct, air escapes
9. Stop the compressor by pushing the OFF button.
10. Open all filling valves carefully to vent.

FIRST COMMISSIONING

Check oil level



Warning

Check oil level daily. Never start the compressor with a too low oil level. Risk of accidental loss, destruction or deterioration.

The oil level should be between the middle and upper end of the oil sight glass. Never start the compressor with a too low oil level.

Refill new compressor oil at least when the oil level reached the middle of the indicated area.

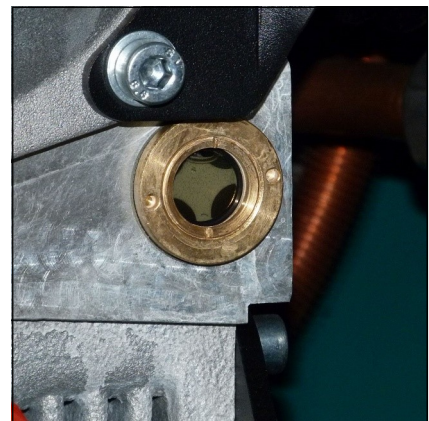

Oil sight glass



Warning

- First oil change after 25 operating hours.

Check V-belt tension

The V-belts could lose tension during transportation. Please check the V-belt tension before starting the compressor.

Tension V-belts / Correct V-belt tension

See chapter "Service and Maintenance" -> "Tension V-belts"

FIRST COMMISSIONING

Check turning direction



Warning

Wrong impeller rotation direction!

Immediately after switching the compressor on, check rotation direction. Depending on the place of installation, the phase sequence can influence the rotation direction.

Before starting the compressor for the first time, check rotation direction (see the rotary direction arrow on the housing of the electric motor).

If the direction of rotation is wrong, the guide pistons of the 2nd and 3rd stages can not be sufficiently lubricated, with the consequence that the pistons will be damaged. Furthermore, cooling air flow will not be sufficient.

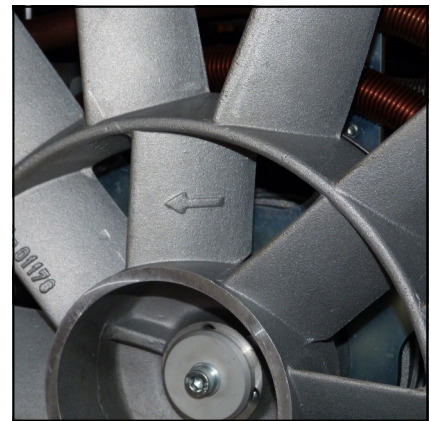

Rotation direction arrow

A



DAILY COMMISSIONING

Prior to daily operation observe the following:

- Ensure cooling air can flow freely.
- Check compressor oil level by the oil sight glass.
- Check if filter cartridge is in place / observe filter cartridge life!
- Ensure toxic-free, pure intake air.

A

OPERATION

Filling procedure



Caution! Fill only cylinders which:

- are marked with the test mark and the test stamp of the expert.
- have been hydrostatic tested (check last test date).
- are rated for the final pressure.
- are free from humidity.



Note

The unit shuts down when final pressure is reached. Thus, the unit always has to be restarted manually.

1. Close all filling valves.
2. Connect the closed compressed air cylinders.
3. Open cylinder valves.
4. Start compressor by pushing the ON button.
5. When the filling pressure gauge increases, open the filling valves slowly.
6. Fill compressed air cylinders to the desired pressure, subsequently close the filling valves slowly.
7. Close and vent all filling valves.
8. Disconnect all compressed air cylinders from filling valves.

A



OPERATION

Switch off the compressor

The compressor unit is equipped as standard with a pressure switch which automatically shuts down the system when the corresponding final pressure is reached.

During filling process, you can shut down the system at any time by pushing the red button (OFF) or the emergency stop (only in case of emergency!).



Note

After automatic or manual switching off, all pressure vessels and filter housings of the compressor will be automatically vented.

A



A

REMEDYING FAULTS

REMEDYING FAULTS

Final pressure can not be reached

Cause of fault	Remedy
Connections leaky	Retighten or clean/replace if necessary
Final pressure safety valve leaky	Replace
Pipes / heat exchanger broken	Replace
Condensate drain valves leaky	Unscrew valves, check sealing surfaces, clean, replace if necessary
Final pressure switch stop unit	Verify settings, replace if necessary
Piston of pneumatic condensate valve sticks	Clean pneumatic condensate valve and restore function, check/replace o-rings, replace valve completely if necessary

Strong compressor vibration

Cause of fault	Remedy
V-belt tension too loose	Tension V-belt
Drive motor / Compressor unit loosely	Retighten mounting screws
Anti vibration mounts used up	Replace
Ground not levelled	Ensure a solid and level ground

Air supply too low

Cause of fault	Remedy
Inlet and outlet valves contaminated / defective	Clean, replace if necessary
Cylinder(s), piston(s) or piston ring(s) used up	Replace
V-belt slips	Tension V-belt
See chapter "Final pressure can not be reached"	See chapter "Final pressure can not be reached"

REMEDYING FAULTS

Compressor overheated

Cause of fault	Remedy
Inlet filter cartridge contaminated	Replace
Ambient temperature too high	Improve room ventilation / Reduce operation times
Cooling air inlet and outlet insufficient	Observe minimum distances (see Installation Instructions)
Air intake hose too long	Reduce length of the air intake hose
Air intake hose diameter too small	Use a larger diameter
Wrong compressor rotation direction	Ensure correct phase rotation, observe rotation direction arrow!
Inlet and outlet valves contaminated / defective	Clean, replace if necessary

Safety valve leaks

Cause of fault	Remedy
Inlet and outlet valves of the following pressure stage defective	Clean, replace if necessary
Sinter filter of the following water separator blocked	Replace
Safety valve leaky	Replace

Oil taste in the air

Cause of fault	Remedy
Mole carbon filter cartridge saturated	Replace
Compressor oil unsuitable	Use prescribed oil quality
Filter cartridge unsuitable	Use prescribed filter type
Cylinder(s), piston(s) or piston ring(s) defective	Replace

REMEDYING FAULTS

Automatic condensate drain defective

Cause of fault	Remedy
Solenoid coils defective	Replace
Cable / supply cable defective	Repair, replace if necessary
Timer / relais defective	Replace
Sinter filter of pneumatic condensate valve blocked	Replace
Piston of pneumatic condensate valve sticks	Clean pneumatic condensate valve and restore function, check/replace o-rings, replace valve complete if necessary

Condensate drain starts before reaching final pressure

Cause of fault	Remedy
Pressure stages are not as prescribed, control pressure of pneumatic condensate valve too low	Check corresponding inlet and outlet valve, replace if necessary.
Piston sealing of pneumatic condensate valve contaminated / used up	Clean, replace if necessary
Timer / relais settings not correct	Adjust as prescribed
Timer / relais defective	Replace

Compressor stops before final pressure

Cause of fault	Remedy
Final pressure switch settings not correct	Correct settings
Opening pressure of the pressure maintaining valve too high	Correct settings
Fuse / circuit breaker has tripped Valid only for E models	Check fusing of the power supply / observe regulations
Emergency stop switch has tripped	Unlock emergency stop switch, close compressor housing door correctly



REMEDYING FAULTS

A

Filter life not sufficient

Cause of fault	Remedy
Pressure maintaining valve settings not correct	Adjust as prescribed
Filter cartridge unsuitable	Replace by a prescribed filter cartridge type
Filter cartridge too old	Observe expiration date
Filter cartridge packaging incorrect / damaged / already opened. Filter cartridge already partly saturated before change	Store filter cartridges properly, dispose defective cartridges
Operating temperature too high	Ensure sufficient ventilation
Cylinder(s), piston(s) or piston ring(s) defective	Replace

Oil consumption too high

Cause of fault	Remedy
Cylinder(s), piston(s) or piston ring(s) defective	Replace
Compressor oil unsuitable	Use prescribed oil quality
Operating temperature too high	Observe prescribed operating temperatures
Oil leak at the compressor block	Tighten corresponding mounting screws, if necessary replace corresponding paper sealing / o-ring / shaft seal



A

MAINTENANCE AND SERVICE

Service, Repair and Maintenance

Carry out service and maintenance work exclusively when the compressor is stopped and depressurised. The unit should be leak-checked regularly. Leaks can be preferably localised by using a leak detector spray (if necessary, brush pipes with soapy water).

We recommend that only authorised L&W service technicians carry out service work on the bearing of the compressor (crankshaft and connecting rods).

We urgently recommend that all maintenance, repair and installation work must only be carried out by trained personnel. This is necessary because all maintenance work can not be explained exactly and detailed in this manual.

Only use authentic spare parts for service work.

**Danger**

Components under pressure, such as hose ends, can quickly come loose when manipulated and can cause potentially fatal injuries due to the pressure surge. Any work on system parts may only be performed in a pressure-compensated state.

**Warning**

The use of accessories that have not been tested can lead to death or serious injury or damage to the unit. Only use authentic spare parts for service work.

**Warning**

Carry out maintenance or service work when the unit is switched off and protected against unexpected restart.

**Warning**

Risk of burns!

Carry out maintenance or service work when the unit has cooled down.



MAINTENANCE AND SERVICE

Daily before taking unit into operation

Maintenance work	Type	Quantity	Order No.
Check oil level	-	-	000001
Check condition of all filling hoses	-	-	-
Check filter cartridge lifetime	-	-	-
Operate unit to final pressure and check function of final pressure switch	-	-	-

At 25 operation hours

Maintenance work	Type	Quantity	Order No.
Oil change	-	0.8	000001

Every 3 months or as required

Maintenance work	Type	Quantity	Order No.
Check automatic condensate drain, open manual condensate taps	-	-	-
Check/Retorque all connections and bolts	-	-	-
Check V-belt tension and condition	LW SC-180 ES (50Hz)	1	011839
	LW SC-250 ES (50Hz)	1	011839

A



MAINTENANCE AND SERVICE

Annually

Maintenance work	Type	Quantity	Order No.
Oil change, if less than 1000 operating hours	-	0.8	000001
Check V-belt tension and condition	LW SC-180 ES (50Hz)	1	011839
	LW SC-250 ES (50Hz)	1	011839
Check opening pressure of final safety valve	-	-	-
Clean coolers	-	-	-
Clean all oil/water separators, if less than 500 operating hours	-	-	-
Service intake filter (depends on condition - if less than 500 operating hours)	-	-	-
Check all connections for leakage	-	-	-

Every 500 operating hours

Maintenance work	Type	Quantity	Order No.
Check V-belt tension and condition	see above	see above	see above
Change intake filter	-	1	001708
Check pressure maintaining/non-return valve	-	-	-
Check all connections for leaks	-	-	-
Clean oil/water separators	-	-	-



MAINTENANCE AND SERVICE

Every 1000 operating hours (latest in 5 years)

Maintenance work	Type	Quantity	Order No.
Replace o-ring of the DIN filling connector	-	2	001237
Replace o-ring of the revolvable filling hose	-	2	001224
Replace sintered metal filter of oil separator	2nd Stage	1	002123
Replace o-ring of the water separator	2. Stufe	1	001255
Replace sintered metal filter of condensate stop	-	1	000188
Replace o-rings of the filter housing	-	2	001769
Oil change (at least once a year!)	-	0,8 l	000001

A



MAINTENANCE AND SERVICE

Every 2000 operating hours (latest in 10 years)

Maintenance work	Type	Quantity	Order No.
Replace o-rings and gaskets of 1st, 2nd and 3rd stage	O-Ring (1st stage)	1	011104
	O-Ring (2nd + 3rd stage)	2	011105
Replace all inlet and outlet valves incl. Gaskets	1st stage	1	003652
	2nd stage	1	000551
	3rd stage	1	011123
	Upper gasket 1st	1	003651
	Lower gasket 1st	1	011103



Note

All stated quantities are parts of our 2000h service kits. You can find an overview on page Service Kits.

A

Tension V-belt

Tension V-belt as follows:

- Loosen mounting screws (Fig. 1)
- Tighten V-belt by the lock nuts (Fig. 2 & 3)
- Tighten mounting screws (Fig. 1)

ATTENTION:

Motor plate (A) and motor (B) must be mounted in parallel (Fig. 4)

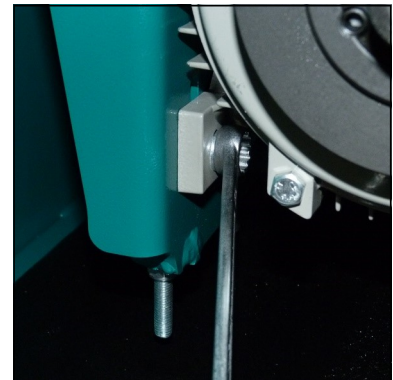

Fig. 1 - Loosen mounting screws



Fig. 2 - Tighten V-belt by the lock nut

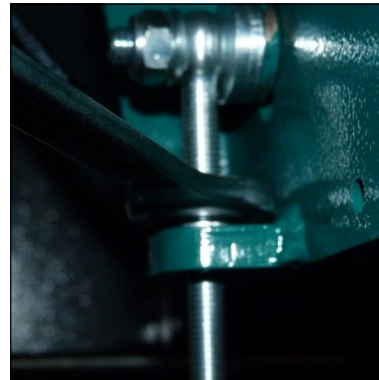

Fig. 3 - Tighten V-belt by the lock nut

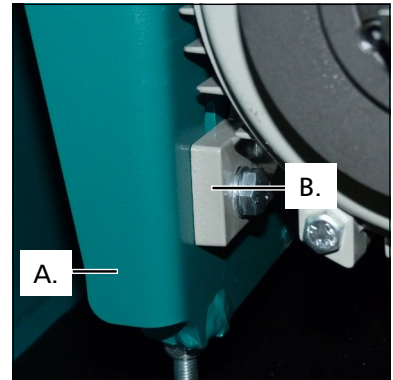

Fig. 4 - Motor plate and motor must be mounted in parallel

Correct V-belt tension

Do not tension V-belts too tight. This damages bearings of compressor and motor. The V-belts should only be tensioned until there is no noise caused by slipping during start.

Settings

Motor Type	Initial Installation	Operation after running in
Electric motors 50Hz	500 N	400 N
Electric motors 60Hz	400 N	300 N

MAINTENANCE AND SERVICE

Compressor Lubrication

Pistons, cylinders, crankshaft and connecting rods are provided with oil by splash lubrication.

A

Check oil level



Warning

Check oil level daily. Never start the compressor with a too low oil level. Risk of accidental loss, destruction or deterioration.

Check oil before each operation of the system!

The oil level should be between the middle and upper end of the oil sight glass. Never start the compressor with a too low oil level.

Refill new compressor oil at least when the oil level reached the middle of the indicated area.

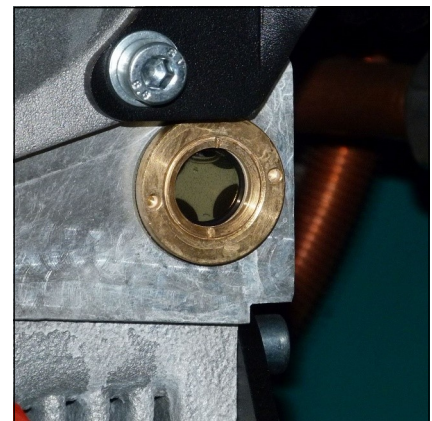

Oil sight glass



Warning

- First oil change after 25 operating hours.

Oil change



Note

We recommend oil change at least once a year - depending on total operating hours.

A

Oil change as follows:

- Run compressor warm for approx. 2 min.
- Switch off and vent compressor.
- Place a suitable oil drain tray under the oil release valve.
- Screw off oil drain plug carefully and remove oil fill port.
- Drain oil completely.
- Close oil drain valve.
- Fill oil by using a funnel.
- Check oil level. The oil level should be between the middle and upper end of the oil sight glass.
- Screw oil fill port manually in and tighten by hand.

The oil change is now completed.

Maintenance intervals

- First oil change after 25 operating hours (total hours).
- Second oil change at 1000 hours (total hours)
- All further changes after each 1,000 operating hours.

Oil and oil capacity

Approx. 800 ml synthetic compressor oil is necessary for one oil change. Only use synthetic compressor oil which is recommended as suitable from L&W (L&W Article no.: 000001).

Final pressure switch



Note

Do not adjust the final pressure switch to the safety valve pressure. The final pressure switch has to be adjusted to min. 10 bar below the safety valve pressure. Otherwise, the safety valve can open during operation. This considerably reduces the life of the safety valve.

The pressure switch shuts off the compressor automatically when the selected final pressure is reached. The final pressure switch is already adjusted to the corresponding cut-out pressure.

The pressure can be adjusted with the upper adjusting screw as follows:

Increasing cut-out pressure:

Turn the adjusting screw clockwise

Reducing cut-out pressure:

Turn the adjusting screw anti-clockwise

Adjust the pressure switch in steps of a quarter turn. Restart the compressor after every adjustment step to verify the actual cut-out pressure.



Final pressure switch

Example settings:

Safety valve	Max. Operating Pressure
225 bar	215 bar
250 bar	240 bar
330 bar	320 bar

Automatic condensation dump system



Note

The collected condensate can contain oil and has to be disposed according to regulations.

The compressor comes as standard with an automatic condensation dump system. Solenoids drain all condensate separators every 15 minutes.

To test the system, press the blue condensate test drain button on the operating panel.

Oil / water separators

Condensate is separated after the 2nd and 3rd stage of compression. All two oil / water separators are equipped with electronic timer controlled solenoids. The timer is located in the switch box and activates the dump valves about every 15 minutes.

To release the complete condensate through the black plastic hoses, we recommend using an 10 l container at least.

The drain noise can be kept to a minimum by using a silencer.

Maintenance intervals

We recommend to clean oil and water separators every 500 operating hours or at least once a year, to check for corrosion damage and to replace o-rings if necessary.

All oil / water separators have an integrated sinter filter which has to be replaced every 1,000 operating hours.

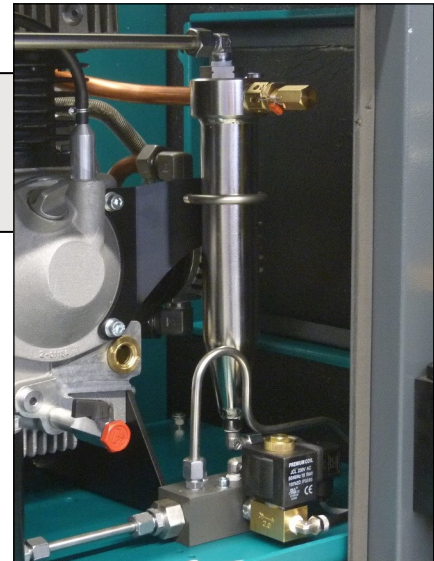

Oil / water separator 2nd stage



Oil / water separators final stage

A

Oil / Water separator 2nd stage - Maintenance



Note

Clean all parts thoroughly before assembly.

Maintain oil / water separator 2nd stage as follows:

- Loosen pipe connections (Fig. 1)
- Loosen screw connection at the water separator (sinter filter holder)
- Remove sinter filter holder (Fig. 2).
- Change sinter filter (Fig. 3), screw-in new sinter filter by using a suitable screwdriver.
- Change o-ring, previously grease new o-ring (Fig. 4)
- Place sinter filter holder into the water separator and tighten
- Connect pipe connections and tighten.

The oil / water separator maintenance is now completed.

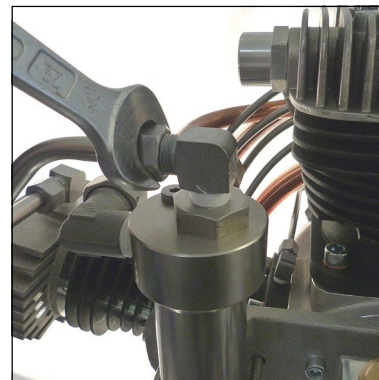

Fig. 1 - Loosen pipe connections

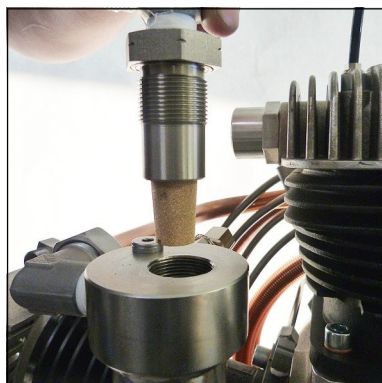

Fig. 2 - Remove sinter filter holder



Fig. 3 - Change sinter filter



Fig. 4 - Change o-ring

MAINTENANCE AND SERVICE

Filter housing

The mole carbon filter housing is installed on the right hand side of the compressor housing.

Inside the filter housing a jet blows air on to the housing wall. Condensation water and oil are led by centrifugal force to the bottom of the housing. Air flows through the mole carbon filter cartridge, which purifies the air from residual moisture and odours.



Filter housing

A



Caution

Do not run the compressor with empty unfilled cartridges.
Only use genuine L&W cartridges.

Filter cartridge

The high-pressure compressor is equipped with an integrated breathing air purification system. Air is compressed up to 330 bar, dried and odour- and tasteless purified. Oil residues are bounded. The breathing air filter cartridge consists of a molecular sieve and activated-carbon filter.

All breathing air filter cartridges are factory vacuum sealed.

We recommend unpacking the filter cartridges just before installation. Filter cartridges which are exposed too long could be saturated with moisture and become unusable.

P/N	Filtering	Models	Filter Volumen
011174	LW SC-180 ES	DIN EN 12021 (Breathing Air)	0,69 l
011174	LW SC-250 ES	DIN EN 12021 (Breathing Air)	0,69 l

Maintenance intervals

Breathing air filter cartridges should be changed at the following intervals, at +20°C or more often, depending on humidity and ambient temperature:

- 46.3 hours for LW SC-180 ES
- 33.3 hours for LW SC-250 ES

MAINTENANCE AND SERVICE

Filter cartridge change

Filter cartridge change as follows:

- Stop the compressor and carefully open the drain valves. Wait till the filter housing is completely vented; this procedure takes approx. 1 - 2 minutes
- When no air discharges from the condensate release hoses, the pressure vessels are depressurized.
- Remove the end filter topcap (Fig. 1 / Fig. 2). Remove the filter cover by using the filter tool. The housing can not be opened if still under pressure.
- After opening the housing, pull out the filter cartridge (Fig. 3).
- Open the vacuum sealed packet of the new filter cartridge and carefully place it into the filter housing (press slightly).
- Screw the filter housing cover in by using the filter tool and turn it back $\frac{1}{4}$ turn. This avoids tightening of the cover due to vibration.

The filter cartridge change is now completed.



Note

Ensure that the old filter cartridge is disposed correctly at an approved waste point.



Fig. 1 - Loosen filter housing topcap by using the filter tool



Abb. 2 - Filtergehäusedeckel entnehmen



Fig. 3 - Pull out the filter cartridge by the catch and insert a new cartridge

Filter housing - maintenance



Note

Clean all parts thoroughly before assembly.

Filter housing maintenance as follows:

- Unscrew filter housing cover by using the filter tool (Fig. 1).
- Change o-ring, previously grease new o-ring (Fig. 2)
- Screw the filter housing cover in by using the filter tool and turn it back $\frac{1}{4}$ turn. This avoids tightening of the cover due to vibration (Fig. 1).
- Remove the bracket (Fig. 3).
- Remove the filter housing.
- Change lower o-ring, previously grease new o-ring.
- Mount the filter housing.
- Mount the bracket (Abb. 3).

The filter housing maintenance is now completed.



Fig. 1 - Remove/screw in filter cover



Fig. 2 - Change o-ring



Fig. 3 - Mounting bracket

Pneumatic condensate valve - maintenance



Note

Clean all parts thoroughly before assembly.

Pneumatic condensate valve change as follows:

- Loosen pipe connections and mounting screws.
- Remove pneumatic condensate valve.
- Loosen connection (Fig. 2).
- Change sinter filter (Fig. 3).
- Tighten horizontal screw.
- Mount pneumatic condensate valve.
- Tighten pipe connections and mounting screws.

Pneumatic condensate valve maintenance is now completed.

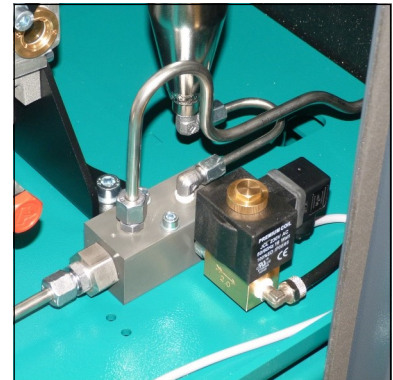

Pneumatic Condensate Valve

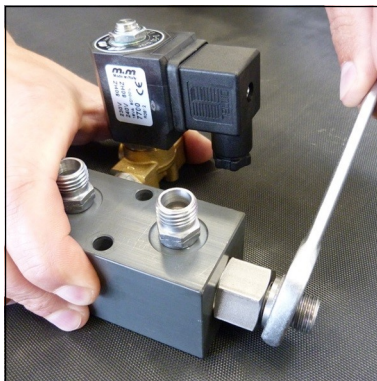

Fig. 2 - Loosen connection

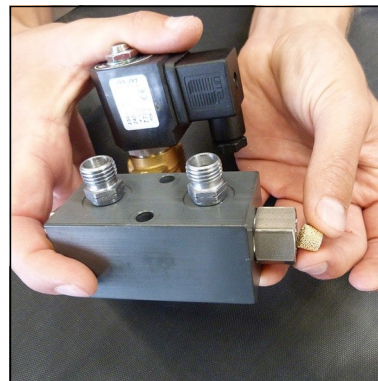

Fig. 3 - Change sinter filter

Check or change filter inlet



Note

Clean all parts thoroughly before assembly.

To properly change the filter inlet, proceed as follows:

- Disconnect the crankcase housing at the ventilation hose (Fig. 1).
- Remove mounting screw and pull out filter housing carefully (Fig. 2).
- Clean filter housing and o-rings and check if defective (fissures).
- Place o-ring into the housing (Fig. 3).
- Insert the new cartridge and assemble the housing. Place o-ring into the groove (Fig. 4).
- Place and align the filter housing carefully, inlet port up, hose connector 90° turned to the left (Fig. 5).
- Tighten mounting screw and connect the crankcase housing ventilation hose to the oil fill port (Fig. 6).

The filter inlet change is now completed.



Fig. 1 - Pull off ventilation hose at the oil fill port



Fig. 2 - Pull out filter housing carefully



Fig. 3 - Place o-ring into the filter housing



Fig. 4 - Place o-ring into the groove

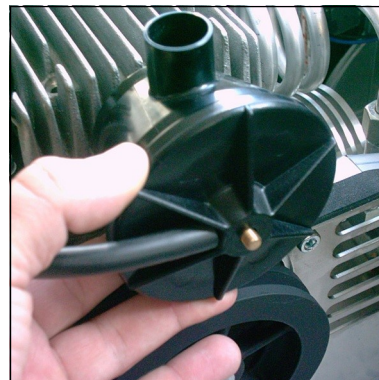

Fig. 5 - Place and align filter housing carefully

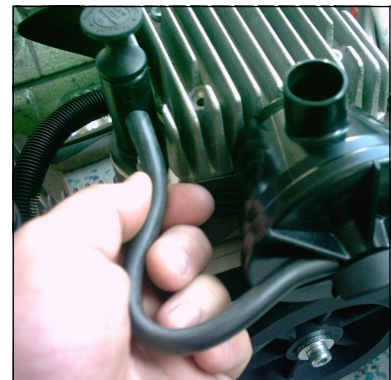

Fig. 6 - Connect ventilation hose at the oil fill port

MAINTENANCE AND SERVICE

Cylinder heads and valves

Inlet and outlet valves of the specific compressor stages are located between valve head and cylinder. Outlet valves open while piston upstroke or compression stroke, inlet valves open while downstroke.

Valves are subject to normal wear and tear and have to be replaced at certain intervals (depending on specific operating conditions). Dismount valve heads to change valves. The three valves are combined inlet and outlet valves. The first stage is a plate valve. The stages two and three are made of a spring operated piston which acts inside a bronze cylinder.



Inlet and outlet valve incl. gaskets of the 3rd stage

Maintenance intervals

All valves should be replaced after 2000 working hours due to normal wear and tear. To replace valves the cylinder heads have to be removed. There are no special tools required to replace these valves.

Available special tools

Special tools are not necessary for dismounting inlet and outlet valves but make work easier.

Order number: 006847



Special tool

Replace in- and outlet valve 1st stage



Note

The figures of the parts can differ due to the different stages.

Replace the inlet and outlet valve 1st stage as follows:

Remove inlet / outlet valve

- Remove spring wire clamps of the crankcase ventilation hose (Fig. 1).
- Remove hose.
- Loosen pipe connections.
- Loosen valve head screws.
- Remove valve head and check if defective.
- Remove upper valve head gasket and inlet / outlet valve.

Install inlet / outlet valve - see following page

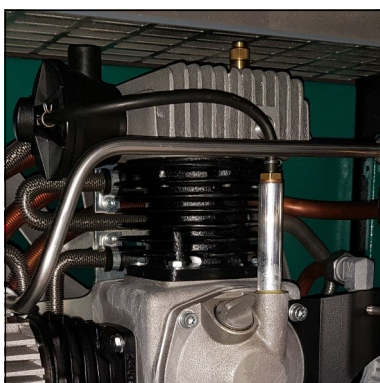

Fig. 1 - Remove spring wire clamps

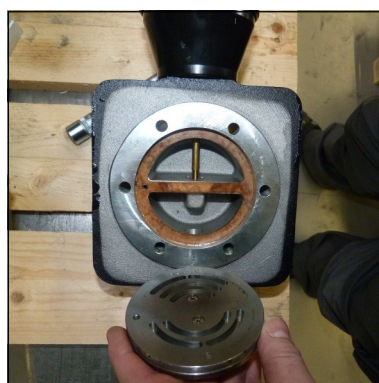

Fig. 2 - Remove in- and outlet valve

MAINTENANCE AND SERVICE

Replace in- and outlet valve 1st stage



Note

The figures can differ from the delivered parts.

Replace the inlet and outlet valve 1st stage as follows:

- Insert lower valve gasket (Fig.1).
- Insert upper valve gasket (Fig.2).
- Insert in- and outlet valve. CAUTION: Observe correct position between valve centre hole and valve head locating pin (Fig. 2+3).
- Place valve head carefully on top of the cylinder (take care to keep valve in place) (Fig.4)
- Tighten valve head screws crosswise.
- Set tight connecting nut and fix vent hose to air intake housing. Don't forget to fix spring wire clamp.



Fig. 1 - Lower valve gasket



Fig. 2 - Correct position of in and outlet valve

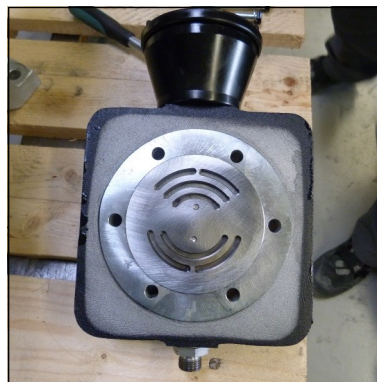

Fig. 3 - Correct position of in and outlet valve

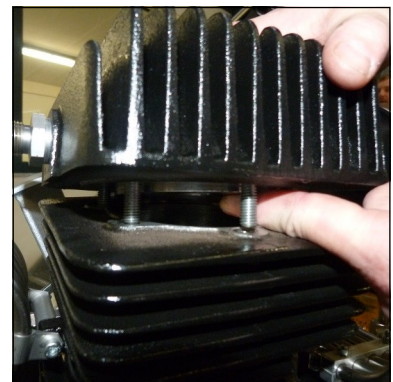

Fig. 4 - Take care to keep valve in place

Inlet and outlet valves change 1st stage is now completed.

Replace inlet and outlet valve 2nd stage / 3rd stage



Note

The figures of the parts can differ due to the different stages.

Replace the inlet and outlet valve 2nd stage as follows:

- Loosen pipe connections.
- Loosen valve head screws.
- Remove valve head Observe that the lower valve gasket is also pulled out. It can still stick inside the cylinder head.
- Remove inlet / outlet valve.
- Check valve head if defective (check locating pin).
- Change upper valve gasket.
- Change lower valve gasket (aluminium gasket).
- Insert new inlet and outlet valve into the valve head (Fig. 1). CAUTION: Observe correct position between valve centre hole and valve head locating pin.
- Place the valve head with the new inlet and outlet valve.
- Place pipe connections.
- Tighten valve head screws crosswise.
- Tighten pipe connections.

Inlet and outlet valves change 2nd stage / 3rd stage is now completed.



Fig. 1 - Ensure correct valve position (centre pin)

Safety valves

Every pressure stage is equipped with a separate over pressure safety valve. Safety Valves avoid a non permissible high pressure at the specific pressure stages and limit maximum operation pressure of the compressor.

Safety valves are adjusted to:

- 1st Stage: 8 bar
- 2nd Stage: 70 bar
- 3rd Stage: max. final pressure

The adjusted blow-off pressure [bar] of the safety valves is indicated on their housings.

All safety valves are factory sealed with special L&W safety seals to avoid manipulation of the limit value settings.

Safety valves with removed seals have to be immediately checked for the prescribed settings and replaced if necessary.

The safety valve of the final stage is furthermore equipped with a knurled screw to be activated once.

Turning the knurled screw clockwise could vent the valve completely and therefore the final filter housing.

During normal operation conditions, the knurled screw has to be turned anti-clockwise up to the upper stop. An integrated circlip avoids complete unscrewing.

If a safety valve blows off, it indicates problems with either inlet or outlet valve of the following stage.



Note

Replace defective safety valves immediately!

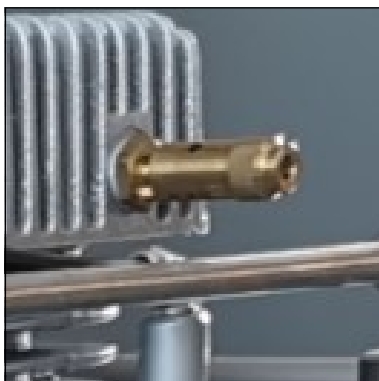

Safety valve 1st stage



Safety valve 2nd stage



Safety valve 3rd stage

Pressure maintaining / non return valve

The pressure maintaining / non return valve combination is placed in the flow direction after the final filter housing.

Pressure maintaining valve

The pressure maintaining valve drains a large part of the water content of the compressed air mechanically by ensuring the minimum outlet pressure. This guarantees optimal drying and purification of the breathing air.

After starting the compressor, the pressure inside the final filter housing constantly increases. The pressure maintaining valve prevents the compressed air from blowing off (final pressure gauge = 0 bar).

When the adjusted opening pressure is reached (160 bar), the purified compressed air flows via pressure maintaining and non return valve to the filling valve.

The value of the opening pressure of the pressure maintaining valve can be read at the final pressure gauge. When opening pressure is reached, the pressure gauge value increases within a few seconds.

Adjust pressure maintaining valve see next page.

Non return valve

The non return valve which is placed after the pressure maintaining valve, prevents the purified breathing air from flowing back into the filter housing / condensate drain valves.

After compressor stop, the indicated filling pressure remains constant, if the non return valve is working correctly.

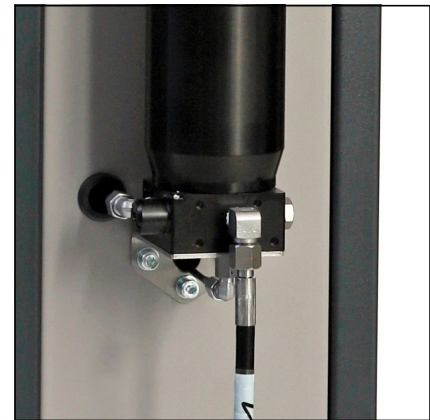

Druckhalte-/Rückschlagventil im Filtersockel mit HD-Abgang

A

Safety valve test



Note

Do not fill any tank during test phase!

Safety valve test as follows:

- Depressurise the system.
- Turn the adjusting screw of the final pressure switch one turn clockwise (please see chapter "Final pressure switch", page A-46).
- Start the compressor.
- Watch the final pressure gauge. The safety valve should open when reaching working pressure of the compressor. If not, switch off the unit and take out of service until the safety valve has been replaced.
- Switch off the compressor.
- Turn the adjusting screw of the final pressure switch back (one turn counterclockwise).
- Check the cut-out pressure. Adjust if necessary!

The safety valve test is now completed.



Pressure switch

Leak test

**Note**

Do not fill any tank during test phase!

**Note**

Two person are recommended for the test!

Leak test as follows:

- Close filling valves.
- Start the compressor.
- Press the OFF-switch and hold on the button.
- Verify the compressor for release noises. (A slight hiss of the air inlet filter nozzle can be ignored). If release noises occur, localise blow off position(s).
- Release the OFF-switch.

The leak test is now completed.



OFF-switch

MAINTENANCE AND SERVICE

Test of Pressure Equipment

According to the Pressure Equipment Directive 2014/68/EU and TÜV Darmstadt (German supervising authorities).

Subject: pressure equipment with a product permissible operating pressure [bar] x content volume [litres] from 200 up to 1000.

Example: Filter housing 0.69 l

Maximum operating pressure: 350 bar

Content volume: 0.69 litres

$350 \text{ bar} \times 0.69 \text{ litres} = 241.5$

241.5 is bigger than the minimum of 200 -> therefore a test by a licensed expert is required.

1. Examination after 5 years by a qualified person or authorized organisations.

Visual inspection, inside and outside.

2. Examination after 10 years by a qualified person or authorized organisations.

Visual inspection, inside and outside.

In addition, a water pressure test is carried out at 1.5 times of the permissible vessel operating pressure.

Max. numbers of load cycles for operation with max. allowable pressure variation		
Final pressure [bar]	Load cycles	Operating hours [h]
350	35.000	8.750



Caution

The filter container (P/N: 011281) has to be replaced after 15 years!



A

MAINTENANCE RECORDS



MAINTENANCE RECORDS

Introduction form for the Operator

A

No.	Surname, Name	Date	Place	Signature	Instructor

By adding themselves to this list, the person that signs it confirms having been given a yearly introduction/instruction about the function and operation of the compressor unit. Furthermore, they have be informed about the relevant safety rules and regulations (TRG, DGRL, BetrSichV, GSG, GSGV).



MAINTENANCE RECORDS

Top up oil, oil change

A

Date	Operating hours	Oil quantity [l]	Name



MAINTENANCE RECORDS

Cartridge change

Date	Operating hours	Difference	Name

A



MAINTENANCE RECORDS

Maintenance work

A

Description	Date, signature



MAINTENANCE RECORDS

Replaced Parts

Designation	Part number	Date, signature

A

Conservation / storage of the compressor

If the compressor unit is not to be used for an extended period of time, we recommend to carry out the following work before storage time:

- Run the compressor at 200 bar filling pressure for approximately ten minutes (control the flow with the filling valve to maintain constant pressure).
- Replace compressor oil, open filling valve(s) and run compressor for a few minutes.
- Stop compressor and open drain valves (depending on the compressor type, this may happen automatically). Remove top cap of final filter housing: clean thread, grease o-ring and thread with a food grade grease or silicone grease. Close filter housing.
- Remove intake filter cartridge and undo intake pipes on all valve heads.
- Start compressor unit. Spray a few drops of compressor oil into intake connectors.
- Stop compressor unit and insert intake filter cartridge. Bring intake pipes back in position and fix connections and nuts. Close filling- and drain valves.
- Store the compressor in a cool dry place free from dust and contamination. A dust cover is recommended as long as condensation can be avoided.
- If compressor unit should be stored for a period of more than one year, an oil change is strongly recommended before it's been re-used.
- Fuel driven units only: fill up fuel tank to top level to avoid corrosion.

De-conservation, commissioning

After the compressor has been stored, the following steps are to be taken:

- If compressor hasn't been used for longer than 12 months, we strongly recommend an oil change before any use.
- Replace intake filter cartridge and check oil level.
- Clean compressor unit, check for foreign objects. Check condition and tension of V-belts, replace if necessary. Check condition of filling hoses, replace if necessary.
- Secure hoses against whipping and open filling valves and run compressor for approximately 10 minutes.
- Check condition of final filter cartridge, replace if necessary.
- Close filling valves and run compressor up to final pressure.
- Check safety valve relief pressure of final stage and/or pressure switch setting.
- Check all connections and pipe work for leaks.

Once all above steps are completed, compressor unit is now ready for use.

Transportation instructions

- Parts which need to be dismantled for transport purposes must be carefully replaced and secured before taking into operation.
- The transport may only be carried out by trained personnel.
- For transportation, only use lifting devices and equipment with sufficient lifting power.
- Do not stand or work under suspended loads.
- Also separate from minor relocation machinery / system of any external energy supply. Before recommissioning, reconnect the machine to the mains according to regulations.
- When recommissioning, proceed according to the operating instructions..

Disposal

The product must be disposed in accordance with national waste disposal regulations and by an appropriate waste disposal company.

Electric and electronic components

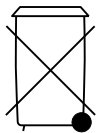

EU-wide regulations for the disposal of electric and electronic appliances which have been defined in the EU Directive 2002/96/EC and in national laws are effective from August 2005 and apply to this device.

Common household appliances can be disposed by using special collecting and recycling facilities. However, as this device has not been registered for household usage, it must not be disposed of through these means.

The device can be returned to L&W. Please do not hesitate to contact us if you have any further questions on this issue.



ATTACHMENT

E

Lenhardt & Wagner GmbH

**An der Tuchbleiche 39
D-68623 Lampertheim – Hüttenfeld**

www.lw-compressors.com



Operating Instruction

Safety valve

Typ:

SiV2 BKZ TÜV.SV.19-1140.5.G.V.P CE 0091 AlMgSi1 F31 1100* Lenhardt & Wagner

Set pressure:	see mark (hand wheel on top of valve)
Maximum outflow:	Set pressure 100-159 bar: 750 l / min Set pressure 160-350 bar: 1.100 l / min
Suitable media:	Media-resistant, non-corrosive gases

The safety valve is used for protection of pressurized components, eg pipelines, pressure vessels, or the compressor itself.

The hand wheel on the top of the safety valve is marked with the adjusted set pressure.



- 1) Identification of set pressure
- 2) Seal
- 3) Fixing screws¹
- 4) Venting screw (hand wheel)
- 5) Identification serial number
- 6) Socket for safety valve

Safety valve with socket

¹ The fixing screws M8 must be strength class 8.8 and meet the requirements of Merkblatt AD 2000 leaflet W7. Shaft length 70mm.

In order to prevent manipulation of the set pressure, all safety valves are factory fitted with a seal.

A safety valve on which the seal has been removed, must be returned to the manufacturer for repair / adjustment before further use.

In addition, the safety valve has a venting device (hand wheel).

When rotated clockwise, the safety valve and the filter housing of the final stage are completely vented.

During normal operation, the screw is unscrewed to the upper stop anticlockwise; an integrated safety ring prevents the screw from being removed.

If a safety valve blows off, the system must be switched off immediately and the cause of the error, investigated.

There are two possible reasons:

1. The safety valve is defective and blows off before the set pressure.

In this case the safety valve should be submitted immediately to the manufacturer for repair or replaced with a new one.

2. The safety valve opens properly, the problem is on the system.

A constant blowing of the safety valve is not permitted, the sealing seat of the valve can be damaged. The error on the system must be detected and repaired before further filling operations.

The safety valve may only be used if it is ensured that the maximum flowrate of the system does not exceed the blow-off rate of the safety valve.

The safety valve may only be used with the approved media.

Repair work on compressors must only be performed by trained personnel.

Dismantling of the safety valve

Ensure that on the safety valve is no pressure.

Loosen and remove the two M8 fixing bolts with a 6 mm Allen key.

The safety valve can now be removed by turning and simultaneously pulling out of the socket.

Mounting

1. Clean the safety valve socket.

2. Oil the insert pin of the safety valve including the O-ring with 1 to 2 drops of oil.

3. Press the safety valve pin complete into the socket.

4. Fasten the safety valve with the two 8 mm allen screws into the socket
(Tightening torque: 10 Nm)

5. Screw the venting screw (hand wheel) anticlockwise to its upper limit.

6. Start the System (Compressor), check installation for leaks and proper function.

Manufacturer: Lenhardt & Wagner GmbH
An der Tuchbleiche 39
D-68623 Lampertheim – Hüttenfeld

Contact: E-Mail: service@lw-compressors.com
Web: www.lw-compressors.com
Tel.: +49 (0) 6256 – 85880 0
Fax: +49 (0) 6256 – 85880 14

Note:

Only use safety valves which are in a technically perfect condition, for its intended purpose, safety and danger awareness, in compliance with the operating instructions!
Faults which could affect safety must be rectified immediately!

Notes:

- The safety valve must be installed directly on the protected pressure vessel and / or the plant.
 - The safety valve must be installed in an upright position.
 - The flow area of the port must be greater than the valve opening.
 - Protect valve against splashes
-

Maintenance:

- In accordance with current Pressure Equipment Directives, the safety valve must be periodically checked for operation and reliability.
- Refill annually lubricating oil:
Oil filling position:
Hole on the spacer (see arrow, Figure 1)
- Oil level: Fill oil into the hole until oil comes out of the hole.

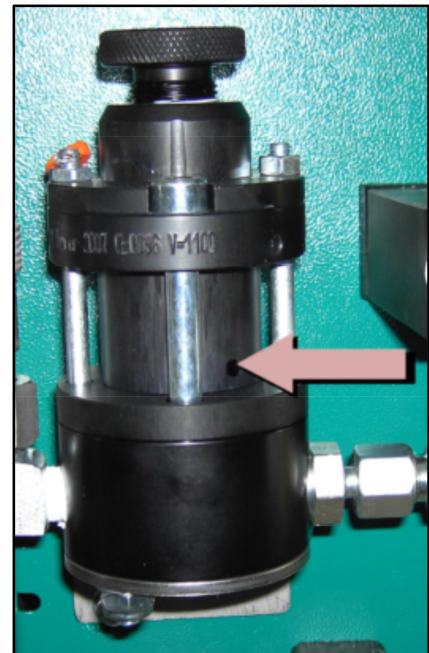

Figure 1: Position for oil refill

To be used lubricating oil for the safety valve: L&W Article N°.: 008500 (content: 30 ml)



INFORMATION ON THE
SERVICE LIFE OF
L&W HIGH PRESSURE HOSES





CONTENTS

Testing hose lines	
Testing hose lines	3
Testing after assembly and before commissioning	3
Recurring test	4
Procedure for hose lines found to be "defective"	4
Test intervals.....	4
Persons qualified to test hose lines.....	5
 Maintenance	
Replacing hose lines	6
Immediate replacement of hose lines	6
 Service life	
Service life of L&W high pressure hoses.....	7
 Storage	
Storing hose lines	8
 Annex	
Scope of testing, test criteria	10 - 11



TESTING HOSE LINES

Testing hose lines

An essential factor in ensuring operational safety when handling L&W compressors is the proper testing of the hose lines used.

Tests are necessary:

- After assembly and before commissioning the hose line.
- After accidents, changes (modifications) to the compressor system, longer periods of non-use and damage due to, for example, collisions or natural phenomena (extraordinary test).
- After carrying out repair work on the compressor system that could compromise safety.
- Recurrently at fixed, regular intervals.

The proprietor must determine the type, scope and deadlines for the tests according to his or her individual operating conditions and on the basis of a risk assessment. **The specifications and recommendations of the manufacturer must be observed.** The specifications made regarding type, scope and deadlines (as well as the replacement intervals) must be documented in writing as occupational health and safety measures.

The results of the tests must also be recorded, e.g. together with the test report of the machine, and kept at least until the next test.

The above-mentioned tests may only be carried out by persons who are qualified to do so and who are authorized by the company (employer).

Testing after assembly and before commissioning

In the test after assembly and before commissioning, factors relating to assembly or factors that can only be evaluated on the fully assembled machine must be assessed.

The assembled hose lines must also be assessed.

Some test points can already be assessed during a visual inspection when the machine is switched off.

An overview of the recommended scope of testing for a visual inspection of hose lines is given in the appendix.

Further test points included in the test of hose lines before commissioning, require a functional test with the machine running.

A recommendation for the scope of testing is given in the appendix.



TESTING HOSE LINES

Recurring test

Since hose lines are subject to influences that cause damage during operation and can lead to dangerous situations, they must be tested recurrently at fixed intervals. The aim of recurring tests is to detect and repair damage in good time.

The objective is to ensure that the system remains in a safe condition.

Procedure for hose lines found to be "defective"

If defects are found during the testing of the hose line that impair the safe condition of the work equipment, these must be rectified immediately. If this is not possible, suitable measures must be taken to ensure that the machine cannot be used further before it is repaired. Defective hose lines must be replaced before the machine can be used further.

It is not permitted to repair or reassemble damaged hose lines with old, previously used parts!

If several hose lines are replaced at the same time, precautions must be taken to prevent mix-ups of the connections or the installation points.

Test intervals

Deadlines for the recurring tests of the hose lines should already be set before commissioning.

Otherwise, there is a risk that work equipment will continue to be used or operated for too long without being tested.

The intervals between the recurring tests must be selected in such a way that deviations from the safe operating condition of work equipment can be detected and eliminated in good time.

The intervals for recurring tests specified here are guidelines and based on experience. Shorter test intervals may have to be specified on the basis of the risk assessment; special operating conditions; or according to the manufacturer's specific instructions in the machine operating manual. Longer test intervals may also be specified, provided that this is justifiable and tenable from a safety point of view. The determination of the test intervals should be documented.

Type of test	Recommended test intervals
Visual inspection	Before commissioning the system
Functional test	Annually with previous visual inspection

Persons qualified to test hose lines

A qualified person is a person who, through his or her professional training, professional experience and recent professional activity, has the necessary specialist knowledge required for testing work equipment - in this case for testing hose lines.

These requirements are defined in the Technical Rules for Industrial Safety TRBS 1203

"Qualified persons - general requirements" fulfilled if:

- the qualified person has completed a professional training that enables his or her professional knowledge to be determined in a comprehensible manner, i.e. based on professional qualifications or comparable evidence. For the testing of hose lines, the person concerned must have completed a technical professional training or another technical qualification sufficient for the intended testing tasks. The object is to guarantee that the tests will be carried out properly.
- proof of practical use at work of the equipment to be tested as well as the associated professional experience is provided. The qualified person must be sufficiently familiar with the conditions that demand the performance of tests, such as the result of the risk assessment or observations during the working day.
- there is proof of recent professional activity in the area of the upcoming tests and appropriate further training. The qualified person must also have gained experience with regard to the tests to be performed or comparable tests. He or she must also have knowledge of the state of the art with regard to the work equipment or components to be tested as well as the hazards to be considered. This also includes knowledge of the relevant technical regulations and the updating of this knowledge, e.g. through participation in training courses/instruction.

The qualified person is not subject to any technical instruction during the course of his or her testing activity and must not be disadvantaged because of this.

Experts who have carried out tests on the hose lines up to now and who meet the three criteria mentioned above and who have familiarized themselves with the contents of the German Ordinance on Industrial Safety and Health and the changes associated with it are also considered qualified persons to whom the tests can continue to be assigned.

See also:

- ⇒ § 2 para. 7 of the German Ordinance on Industrial Safety and Health,
- ⇒ Technical Rules for Operational Safety TRBS 1203.



Replacing hose lines

As a general rule, even when stored properly and subjected to permissible stress during use, all hose lines are subject to natural aging, which changes the material and composite properties and reduces the performance of the hose lines.

This limits the service life of a hose line and the operator must ensure that hose lines are replaced at appropriate intervals.

Immediate replacement of hose lines

Hose lines must be replaced immediately in the event of the following defects:

- External visible damage to the hose line or fittings.
- Internal damage to the tube or the reinforcement.
- Leakage from the hose line or the fittings.
- Deformation of the hose line or the fittings.



SERVICE LIFE

Service life of L&W high pressure hoses

When determining the service life or the replacement interval of the individual hose lines, the concrete specifications and recommendations of the hose line or machine manufacturer must be observed. Furthermore, empirical values resulting from previous tests done under the prevailing operating conditions on site are also relevant.

Guideline values for recommended replacement intervals of hose lines which have proven themselves in practice are summarized below.

Hose line requirements	Recommended replacement intervals
Standard requirements	6 years (Service life including a maximum of 2 years storage time)
Increased requirements, e.g. due to - increased operating time, e.g. multi-shift operation, or short machine or pressure pulse cycle times - strong external and internal influences (due to the medium), which greatly reduce the service life of the hose line	2 years (service life)

The guideline given above for a replacement interval of six years for hose lines meeting normal requirements includes a maximum storage period of two years. The guideline value of two years for hose lines meeting increased requirements represents the maximum permissible service life.

A prolongation of the guideline values given above for replacement intervals is possible if

- appropriate test values and empirical values are available from the operator of the machine which permit safe continued use beyond the recommended maximum service period,
- a hazard or risk assessment, documented in writing, has been carried out by the operator, which also takes into account protective measures in the event of failure of hose lines, and
- tests for safe working conditions are carried out by qualified persons at appropriately set, if necessary reduced, intervals.

It must be ensured that the prolongation of the replacement intervals does not result in a dangerous situation that could injure employees or other persons.

If hose lines fail during operation or if damage or defects are frequently detected during the recurring tests, then, in addition to investigating the causes, the test and replacement intervals must be shortened.



STORAGE

Storing hose lines

When storing hose lines, storage conditions must be aimed at minimizing the natural aging that occurs over time and the associated change in material and composite properties.

For this purpose, the following information must be provided:

- Store in a cool, dry and low-dust place.
Low-dust storage can be achieved, for example, by wrapping the hoses in plastic film.
- Avoid direct sun or UV radiation.
- Shield from nearby heat sources.
- Avoid storage temperatures below -10 °C for elastomers.
- Do not use ozone-generating light fittings or electrical devices that may produce sparks in the immediate vicinity.
(Ozone-generating light fittings are, for example, fluorescent light sources, mercury vapor lamps).

The most favorable storage conditions are temperatures between +15 °C and +25 °C, as well as a relative humidity below 65 %.

During storage, hose lines must not come into contact with substances that could cause damage, e.g. acids, alkalis, solvents. Penetration of ozone or other harmful air constituents can be prevented by sealing the ends or by wrapping the hoses in plastic film. They must be stored flat and free of tension.

The storage period for hose lines should not exceed two years.



ANNEX

Recommended scope of testing "visual inspection" (before initial commissioning or recommissioning)

- Is all user information required for safe operation of the system available (e.g. flow chart, operating instructions)?
- Do the hose lines comply with the flow chart or parts list?
- Are there protective measures in place, such as pressure relief valves, for cases of unusually high pressure pulses or pressure amplifications?
- Are the hose lines marked with the name or abbreviation of the manufacturer, maximum permissible operating pressure, nominal diameter, quarter/year of manufacture?
- Are the hose lines installed in such a way that, in accordance with DIN 20 066
 - the natural position does not hinder movement?
 - turning or twisting of the hose is prevented, likewise tensile load caused by a line that is too short and a bending radii that is too small?
 - the hose is routed via a kink protector (if necessary on the connecting element)?
 - sufficient clearance prevents external mechanical influences or abrasion on the edges?
 - hose bridges prevent damage being caused by driving over the hose line?
 - hose guides (such as hose saddles and sufficiently wide hose brackets) protect loosely laid hose lines and
 - a heat shield protects against high temperature exposure?
- Are suitable protective measures, such as fixtures, safety gear or shielding provided for hose lines that, in the event of failure, pose a risk of whipping?
A risk is to be assumed if persons are generally present in the immediate vicinity of the hose lines, for example.
- Do the hose lines of newly commissioned or re-commissioned machines already show signs of damage?
- Are the installed hose lines still within the storage/use period recommended by the relevant manufacturer?
- Are the hose lines free of paint?
- Are the hose lines free of chafe marks?
- Does the operating manual contain information on test intervals? If so, what?

Note:

The installed hose lines should not be made from used hoses or used press fittings that have already been in use as part of a hose assembly!



ANNEX SCOPE OF TESTING; TEST CRITERIA

Recommended scope of testing "Functional test" (before initial or recommissioning)

Note:

Visual inspection must be carried out before the functional test

- All parts of the system must be tested at least at the maximum working pressure that could be achieved taking into account all intended applications:
 - Are the hose lines and connecting elements free of leakage?
 - Have all hose lines withstood the pressure?

Note:

The installed hose lines should not be made from used hoses or used press fittings which have already been in use as part of a hose assembly!