



CHAPTER OVERVIEW

Operating Instructions

A

ECC - Electronic Compressor Control (if equipped).....

B

Spare Parts Lists

C

Options (if equipped).....

D

Attachment

E

Manufacturer in terms of 97/23/EC

The full name and address of the manufacturer is:

Lenhardt & Wagner GmbH

An der Tuchbleiche 39

68623 Hüttenfeld / Germany

Phone: +49 (0) 62 56 - 85 88 0 - 0

Fax: +49 (0) 62 56 - 85 88 0 - 14

E-Mail: service@lw-compressors.com

Internet: www.lw-compressors.com





SERVICE INFORMATION / WARRANTY

Compressor information

Type designation

Serial number

Date of construction

Purchase information

Purchase date

First commissioned on

Warranty period

Dealer's stamp

Warranty

L&W will uphold warranty claims made during a period of 12 months from the invoice date.

If the compressor was purchased from an official L&W dealer, the date on the dealer's invoice is valid. Warranty claims can only be made on presentation of the original invoice.

Should verifiably defective parts have been delivered, we will decide to either replace the parts or repair them. The resulting transport and assembly costs will be invoiced.

No reduction of the purchase price or changes to the contract can be made. The parts for which a claim is being made should be kept safe by the purchaser and, when requested, sent to us at their cost. Replaced parts become the property of L&W. If maintenance work is carried out without our knowledge or permission by the purchaser or a third party, we are absolved from any liability for warranty claims. As a matter of principle, warranty claims can only be made by the initial purchaser.

Operating Instructions

Breathing Air Compressor

LW 720 E

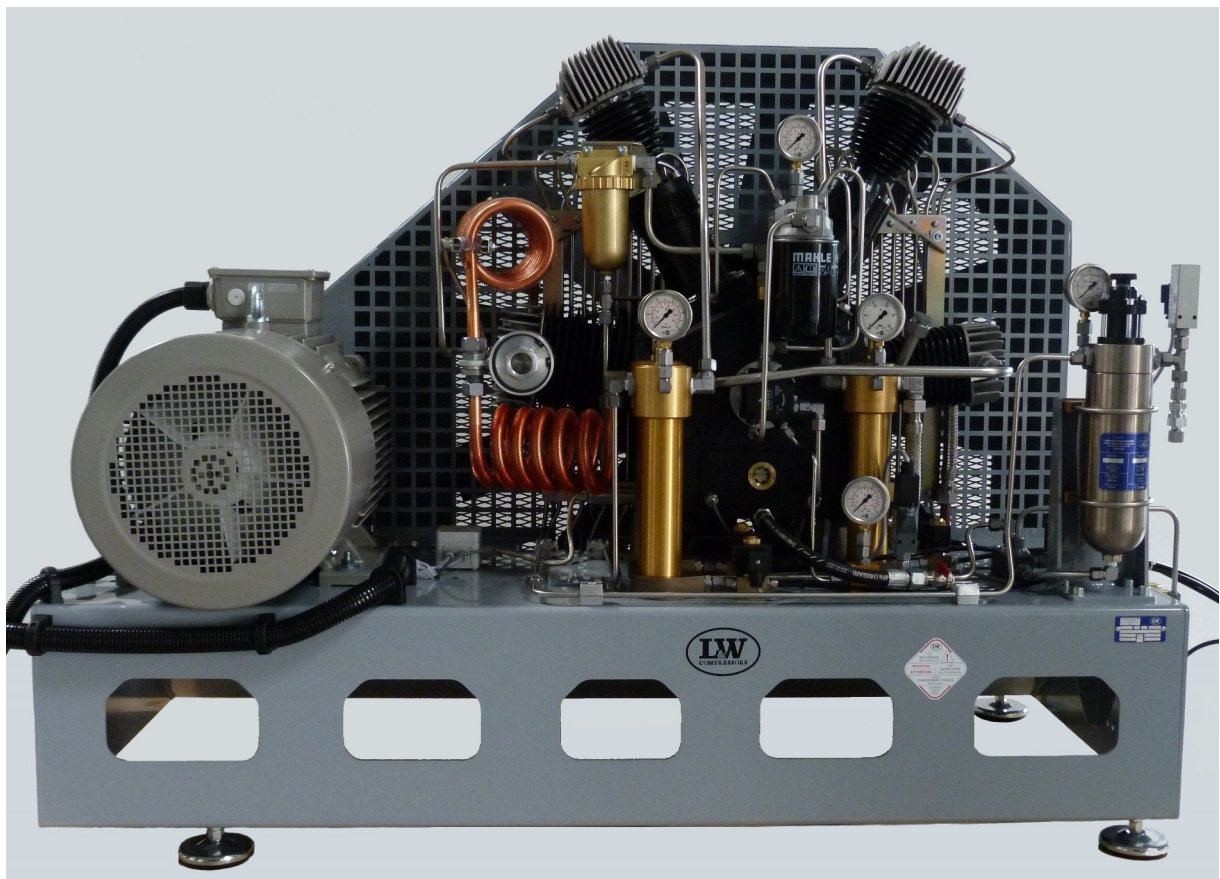



TABLE OF CONTENTS

General Information and Technical Data

General Information / Description of Warning Symbols	4
Scope of Delivery	5
Technical Data	6
Unit Assembly	7
Switchboard	8
Flow chart	9

Safety Precautions

Intended Use / Operators	11
Safety instructions on the unit	12
General Safety Precautions	13
Unit customised safety notices	14
Maintenance instructions	15
Transportation instructions / Safety regulations	16

Installation

Installation in closed rooms	18
Dimensions	19
Minimum distances	20
Ventilation	21
Electrical Installation	22 - 23

Operation

Important operation instructions	25
First commissioning	26 - 28
Daily commissioning	29
Filling procedure	30
Switch off the compressor	31
Interstage pressure gauges	32
Oil pressure gauge and oil distributor block gauge	33
Oil pressure monitoring	34

Remedying faults	36 - 39
-------------------------------	---------

A



TABLE OF CONTENTS

Maintenance and Service

Service, Repair and Maintenance	41
Maintenance Lists / Maintenance Intervals	42 - 45
Check V-belt tension	46
Compressor lubrication / Check oil level	47
Oil change	48
Oil sieve change	49
Final pressure switch	50
Automatic condensation dump system	51
Oil / water separators 1st, 2nd and 3rd stage - maintenance	52
Oil / water separator final stage - maintenance	53
Filter element change 0.8ltr filter housing	54
Pneumatic condensate valve - maintenance	55
Filter housing / Filter cartridge	56
Filter cartridge change	57
Filter housing - Maintenance	58
Inlet filters / Inlet filter cartridge change	59
Cylinder heads and valves / Important torque rates for bolts	60
Safety valves	61
Pressure maintaining / non return valve	62
Safety valve test	63
Leak test	64
Pressure gas vessel test	65
Maintenance records	66 - 71

Storage

Conservation / storage of the compressor / De-conservation, commissioning	73
Transportation instructions / Disposal	74

A

GENERAL INFORMATION

General Information

We strongly recommend reading this manual thoroughly prior to operation and follow all the safety precautions precisely. Damage resulting from any deviation from these instructions is excluded from warranty and liability for this product. Carry out other commissioning steps only if you have fully understood the following contents.

Before commissioning and using the unit, carry out all the essential preliminary work and measures concerning legal regulations and safety. These are described on the following pages of this operation manual.

A

Description of marks and warning signs

The following warning signs are used in this document to identify the corresponding warning notes which require particular attention by the user. The warning signs are defined as follows:



Caution

Indicates an imminently hazardous situation which, if not avoided, could result in serious injury, physical injury or death.



Warning

Indicates a potentially hazardous situation which, if not avoided, could result in physical injury or damage to the product or environment.



Note

Indicates additional information on how to use the unit.



DESCRIPTION

Scope of Delivery

The industrial compressor LW 720 E is suitable for breathing air applications and for large capacities. Low speed ensures continuous operation for long service intervals and reduced maintenance costs. The 4-stage compressor block is mounted on a painted steel panel and is designed for maximum operating pressure of 420 bar. The compressor unit comes fully wired with star/delta start system and includes 2x 2.3 litre breathing air filter console for wall mounting.

A

Versions (Filling pressure versions:)

- PN 225 bar
- PN 330 bar

Specifications

- Electro motor
(Standard: 400V, 3 phase, 50Hz)
- Painted steel frame (RAL 6026)
- Painted steel fan guard (RAL 7001)
- Inclusive a remote control box for wall mounting
- Main-, Start/Stop- and condensate test buttons, as well as emergency stop switch
- Hour counter
- Automatic condensate drain
- Automatic stop at final pressure
- Oil pressure gauge
- Intermediate pressure gauges
- Oil pressure monitoring c/w auto shut down
- High pressure outlet 10L
- Motor protection switch
- Pressure maintaining and non return valve
- All pistons c/w steel piston rings
- Low pressure oil pump and filter
- Oil- / Water separators in stainless steel
- Safety valves after each stage
- 4 concentric suction/pressure valves
- Filling pressure of your choice (200 or 300 bar)
- Inclusive 2x 2.3 ltr filter console for wall mounting
- Breathing air purification in accordance to EN 12021

Options

- Auto start system
- Oil temperature display with auto shut down
- Cylinder head temperature monitoring with auto shut down
- Puracon filter monitoring (Auto shut down also available)
- ECC control in remote control box
- Power cable and plug
- Block heating device
- 420 bar Version
- Special voltages / frequencies on request

DESCRIPTION

Technical Data

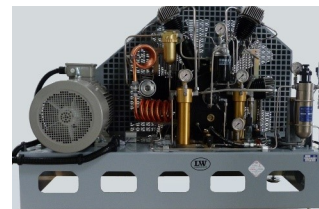

A

Technical Data	LW 720 E
Capacity [l/min]:	720
Max. Operating Pressure [bar]:	350 (Optional 420)
RPM [min ⁻¹]:	1,100
Number of Pressure Stages:	4
Cylinder Bore 1st Stage [mm]:	Ø 115
Cylinder Bore 2nd Stage [mm]:	Ø 55
Cylinder Bore 3rd Stage [mm]:	Ø 25
Cylinder Bore 4th Stage [mm]:	Ø 14
Stroke:	98
Medium:	Air
Lubrication Type:	Oil Pump and Splash Oil
Intake Pressure [bar]:	Atmosphaeric
Oil Pressure [bar]:	+4.0
Oil Capacity [l]:	4.2
Ambient Temperature [°C]:	+5 < +45
Cooling Air Volume [m ³ /h]:	> 5,500
Voltage:	400 V / 3 phase / 50 Hz
Protection Class Drive Motor:	IP 54
Drive Power [kW]:	18.5
RPM Motor [min ⁻¹]:	2,890
Start:	Star/Delta
Noise level [dB(A)]:	88 from a distance of 1 m
Dimensions W x D x H [mm]:	1,650 x 760 x 1,250
Weight [kg]:	ca. 600

DESCRIPTION

Unit Assembly

A

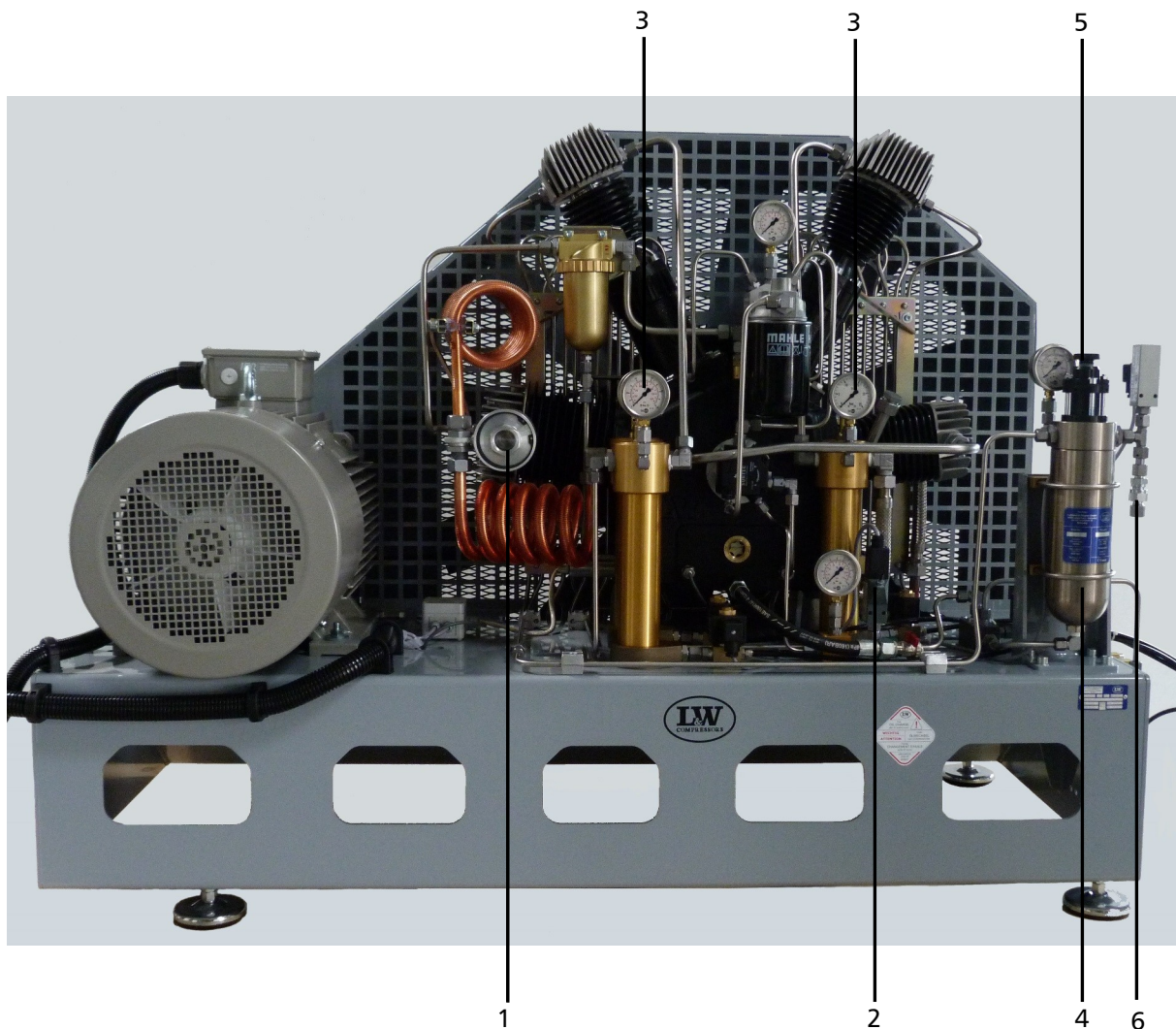

No.	Designation
1	Gastight Inlet Filter Housing
2	Oil Pressure Monitoring
3	Intermediate Pressure Gauges
4	Breathing Air Filter Housing
5	Safety Valve
6	Outlet (10L)

DESCRIPTION

Switchboard

A



No.	Designation
1	Emergency shut-off switch
2	Hour counter
3	ON button
4	OFF button
5	Drain test button

DESCRIPTION

Flow chart

A

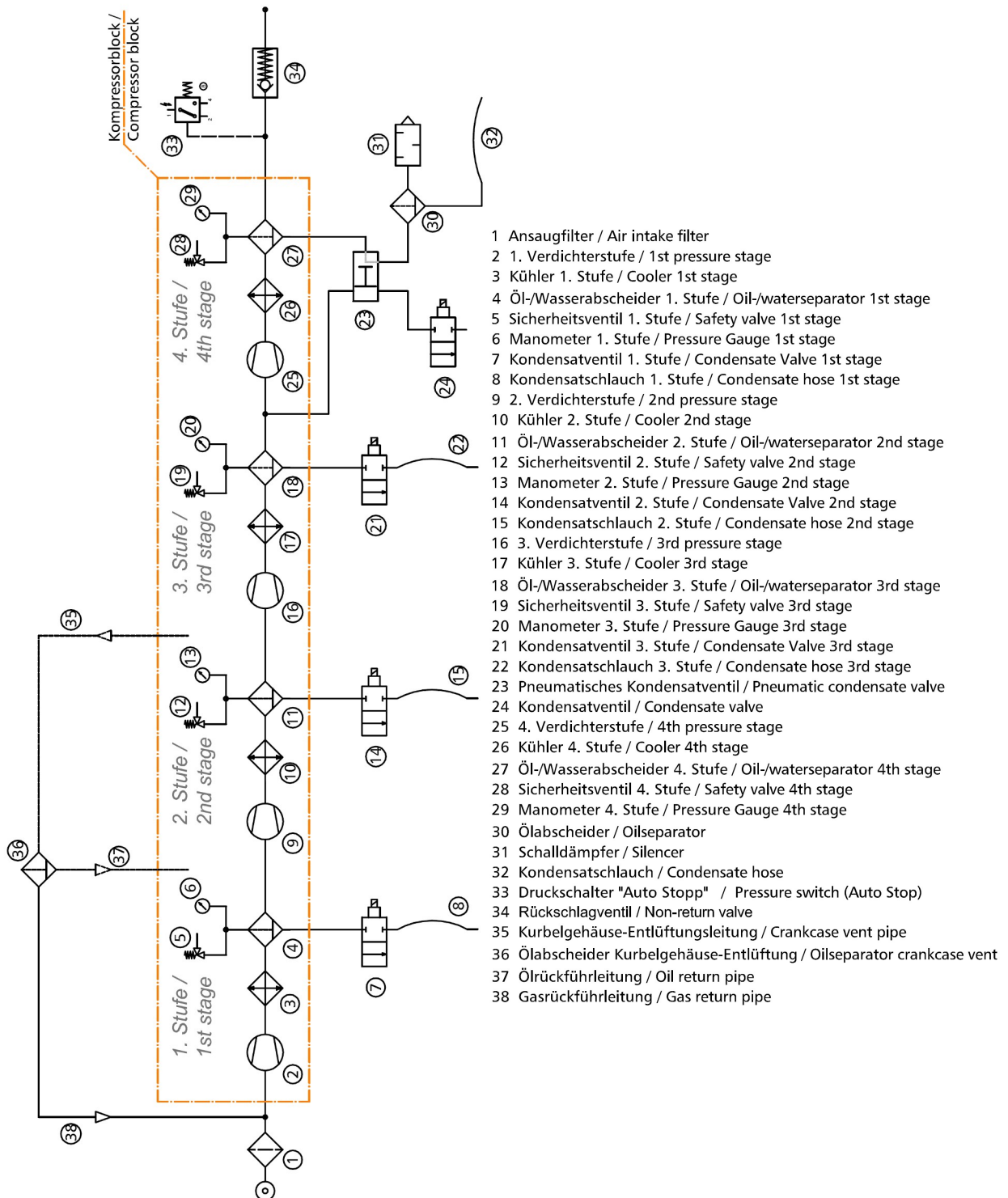



A

SAFETY PRECAUTIONS



SAFETY PRECAUTIONS

A

Intended Use

Only use the unit in perfect condition for its intended purpose, safety and intended use and observe the operating instructions! In particular disorders that may affect safety have to be eliminated immediately!

Use the unit exclusively for the determined medium (see "Technical Data"). Any other use that is not specified is not authorized. The manufacturer/supplier shall not be liable for any damages resulting from such use. Such risk lies entirely with the user. Authorization for use is also under the condition that the instruction manual is complied with and inspection and maintenance requirements are enforced.

No change and modification to the unit can be made without the written agreement of the manufacturer. The manufacturer is not liable for damage to persons or property resulting from unauthorized modifications.

Operators

Target groups in these instructions;

Operators

Operators are persons who are authorized and briefed for the use of the compressor.

Qualified personnel

Qualified personnel are persons who are entitled to repair, service, modify and maintain the system.



Warning

Only trained personnel are permitted to work on the unit!



Warning

Work on the electrical equipment on / with the machine / unit may only be carried out by qualified electricians.

SAFETY PRECAUTIONS

Safety instructions on the unit

Importance of notes and warning signs that are affixed to the compressor according to the application or its equipment.

A



Warning
High voltage!



Note
Ensure correct direction of rotation!



SAFETY PRECAUTIONS

General Safety Precautions

- Read the Operating Instructions of this product carefully prior to use.
- Strictly follow the instructions. The user must fully understand and strictly observe the instructions. Use the product only for the purposes specified in the intended use section of this document.
- Do not dispose the operating instructions. Ensure that they are retained and appropriately used by the product user.
- Only trained and competent personnel are permitted to use this product.
- Comply with all local and national rules and regulations associated with this product.
- Only trained and competent personnel are permitted to inspect, repair and service the product.
- Only authentic L&W parts and accessories may be used for maintenance work. Otherwise, the proper functioning of the product may be impaired.
- Do not use faulty or incomplete products. Do not modify the product.
- Inform L&W in the event of any product or component fault or failure.
- Do not use the product in areas prone to explosion or in the presence of flammable gases. The product is not designed for these applications. An explosion might be the result if certain conditions apply.

A



SAFETY PRECAUTIONS

Unit customised safety notices

Organisational measures

- In addition to the instruction manual, observe and comply with universally valid legal and other obligatory regulations regarding accident prevention and environment protection.
- In addition to the instruction manual, provide supplementary instructions for supervision and monitoring duties taking into consideration exceptional factors e.g. with regard to organisation of work, production, personnel employed.
- Supervise personnel's work in accordance with the instruction manual, taking into account safety and danger factors.
- Observe all safety and danger notices on the compressor and check readability and completeness.

Safety instructions operation

- Take measures to ensure that the machine is only taken into operation under safe and functional conditions. Only operate the compressor if all protective and safety equipment, e.g. detachable protective equipment, are provided and in good working order.
- Check the compressor at least once per day for obvious damage and defects. Inform the responsible department / person immediately if anything is not as it should be (including operation performance). Shut down the machine immediately if necessary and lock it.
- In case of malfunction, stop the compressor immediately and lock it. Repair malfunctions immediately.
- If there is a failure in the electric energy supply, shut the machine / unit down immediately.
- Ensure safe and environmentally friendly disposal of consumables and old parts.
- The stipulated hearing protectors must be worn.
- Soundproofing equipment on the compressor has to be activated in safety function during operation.
- When handling with fats, oils and other chemical agents, observe the note for the product-related safety.

A



SAFETY PRECAUTIONS

Maintenance instructions

- Hoses have to be checked by the operator (pressure and visual inspection) at reasonable intervals, even if no safety-related defects have been detected.
- Immediately repair any damage. Escaping compressed gas can cause injury.
- Depressurise system and pressure lines before beginning repair work.
- Pressurised gas lines must be laid and mounted by qualified personnel. Connections must not be mixed up. Fittings, length and quality of the piping must correspond to requirements.
- Adjustment, maintenance and inspection activities and keep appointments, including information on replacement parts / equipment, prescribed in the operating instructions have to be respected.
- If the machine / equipment is completely off during maintenance and repair work, it must be protected against unexpected restart. Turn off main control device and remove the key and/or display a warning sign on the main switch.
- The machine and especially the connections and fittings should be cleaned from oil, fuel and maintenance products at the beginning of the maintenance / repair. Do not use aggressive cleaning agents. Use fibre-free cleaning cloths.
- Switch off compressor and clean with a slightly damp cloth. Remove dirt from cooling pipes by using a brush.
- After cleaning, examine all pipes for leaks, loose connections, chafing and damage. Immediately eliminate any faults.
- Always retighten any screw connections loosened for maintenance or repair work.
- If it is necessary to remove safety devices for maintenance and repair work, these must be replaced and checked immediately after completion of the maintenance or repair work.
- The electrical equipment of the compressor must be regularly checked. Defects, such as loose screw connections or burnt wires, must be immediately rectified by electrically skilled personnel.
- Only personnel with particular knowledge and experience with pneumatics may carry out work on pneumatic equipment.
- Only personnel with particular knowledge and experience in gas equipment may carry out work on gas equipment.

A



SAFETY PRECAUTIONS

Transportation instructions

- Parts which need to be dismantled for transport purposes must be carefully replaced and secured before taking into operation.
- The transport may only be carried out by trained personnel.
- For transportation, only use lifting devices and equipment with sufficient lifting power.
- Do not stand or work under suspended loads.
- Also separate from minor relocation machinery / system of any external energy supply. Before recommissioning, reconnect the machine to the mains according to regulations.
- When recommissioning, proceed according to the operating instructions..

Safety regulations

- Inspections according to legal and local obligatory regulations regarding accident prevention are carried out by the manufacturer or by authorised expert personnel. No guarantees whatsoever are valid for damage caused or favoured by the non-consideration of these directions for use.

A



A

INSTALLATION

INSTALLATION

Installation in closed rooms



Danger

No operation in explosion-hazard areas.

The unit is not approved for operation in areas prone to explosion.

For installation in closed rooms, observe the following:

- Install the unit horizontally and level. The floor must be vibration-free and capable of taking the load of the system weight.
- The compressor room must be clean, dry, dust free and as cool as possible. Avoid direct exposure to sunlight. If possible, install unit in such a manner that the compressor fan can intake fresh air from outside. Ensure adequate ventilation and exhaust air opening.
- When locating the compressor in rooms of less than 30 m³ space where natural ventilation is not ensured or other systems having high radiation are operating in the same room, measures must be taken to provide artificial ventilation.
- Observe the specified operating temperature (see "Technical Data")!

INSTALLATION

Dimensions

A

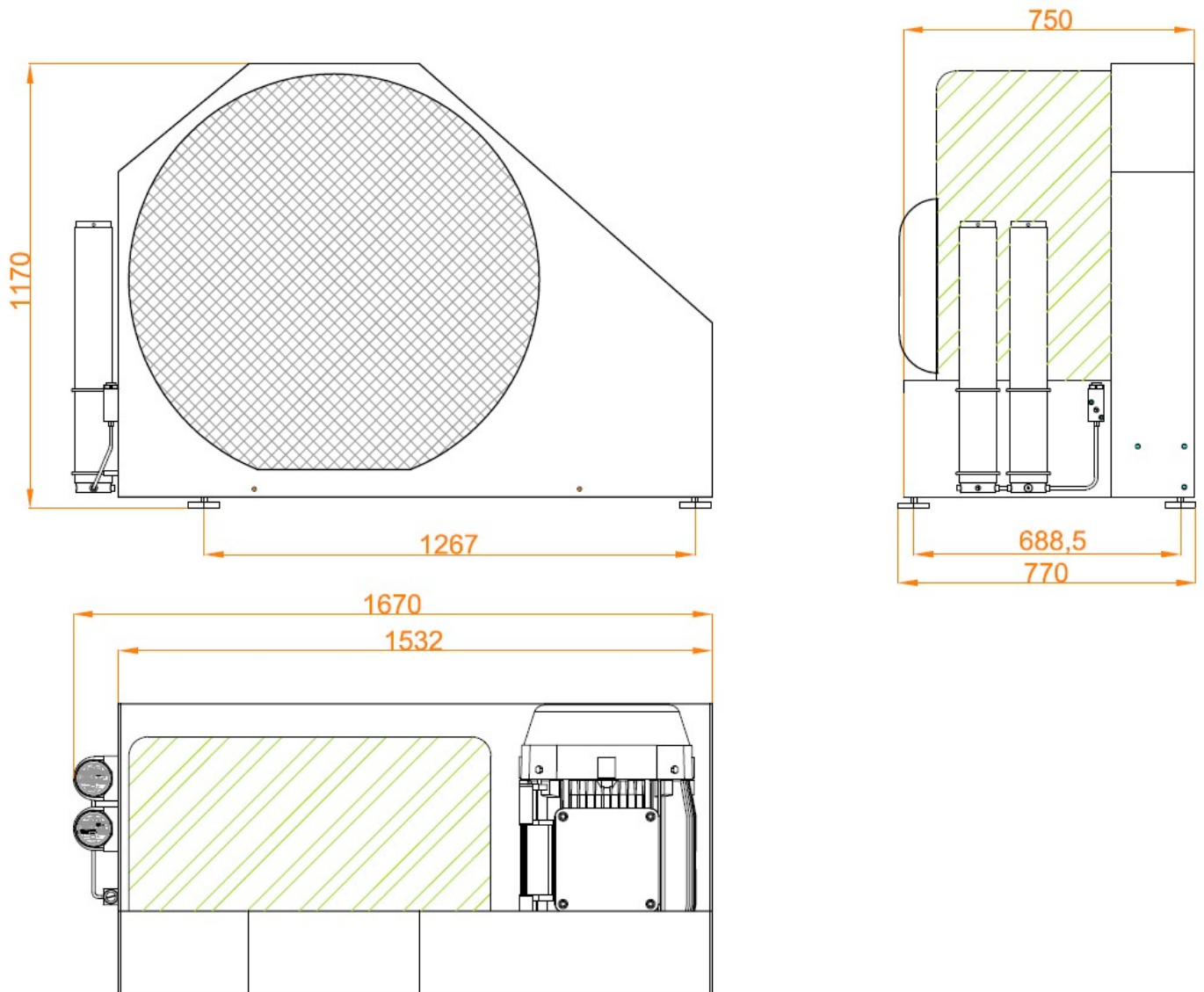

Fig. Dimensions

INSTALLATION

Minimum distances



Note

Minimum distances must be adhered!

- Make sure that the compressor always has a sufficient amount of fresh air available.
- To prevent serious damage, ensure that the cooling air flow can flow freely.
- The following minimum distances must be adhered:
Front side min. 1500 mm, sides and rear side min. 500 mm, distance to the ceiling min. 500 mm.
Avoid anything in this area which can restrict the cooling air flow.

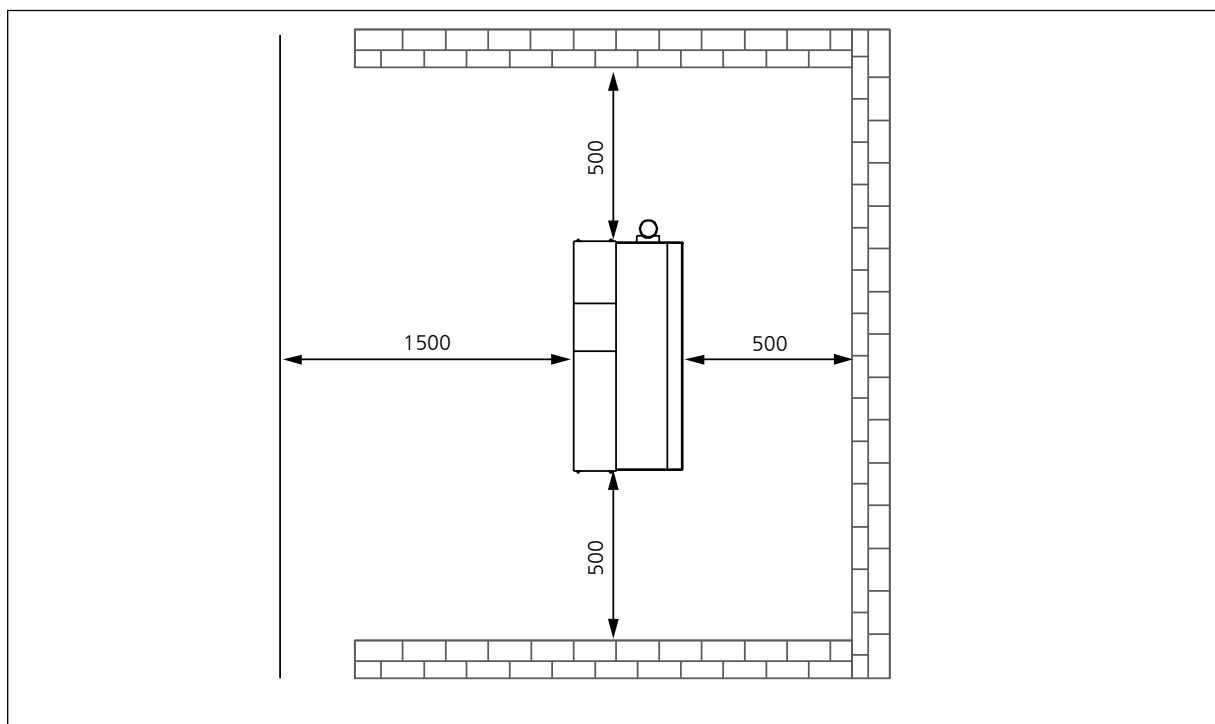

Fig. Minimum distances

INSTALLATION

Ventilation

- Make sure that the compressor always has a sufficient amount of fresh air available for cooling.
- To prevent serious damage, ensure that the cooling air flow can flow freely.
- The necessary cooling air flow can be calculated by using the following formula:
 $300 \times \text{drive power [kW]} = \text{required cooling air flow [m}^3/\text{h]}$
 Example 11kW motor: $300 \times 11\text{kW} = 3300 \text{ m}^3/\text{h} = \text{required cooling air flow.}$
- The fan capacity for fresh air and warm air must meet at least the required cooling air flow.
 The fans must have the same capacity.

A

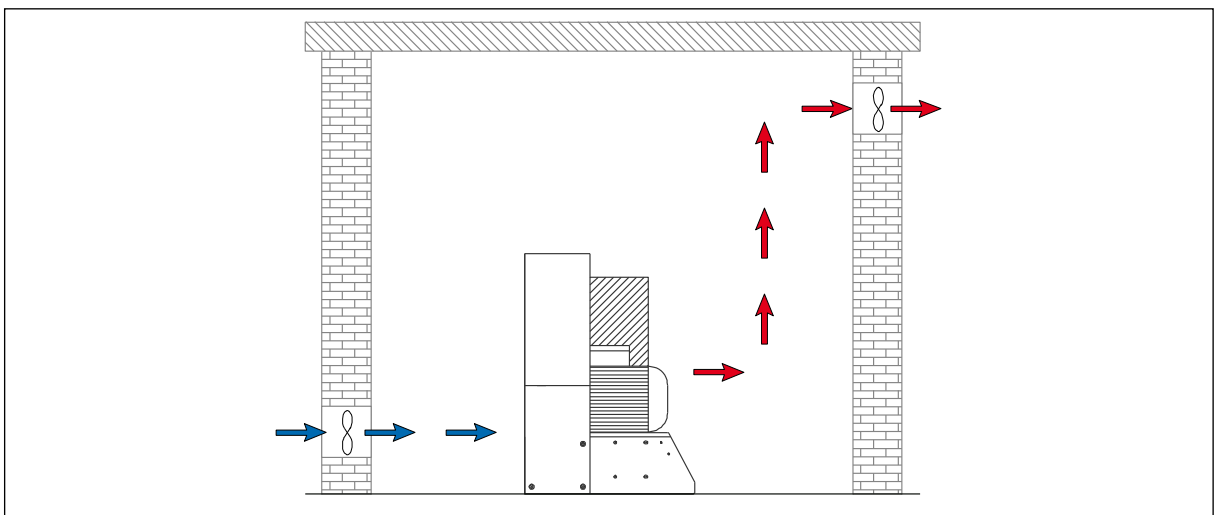

Fig. Ventilation through facade

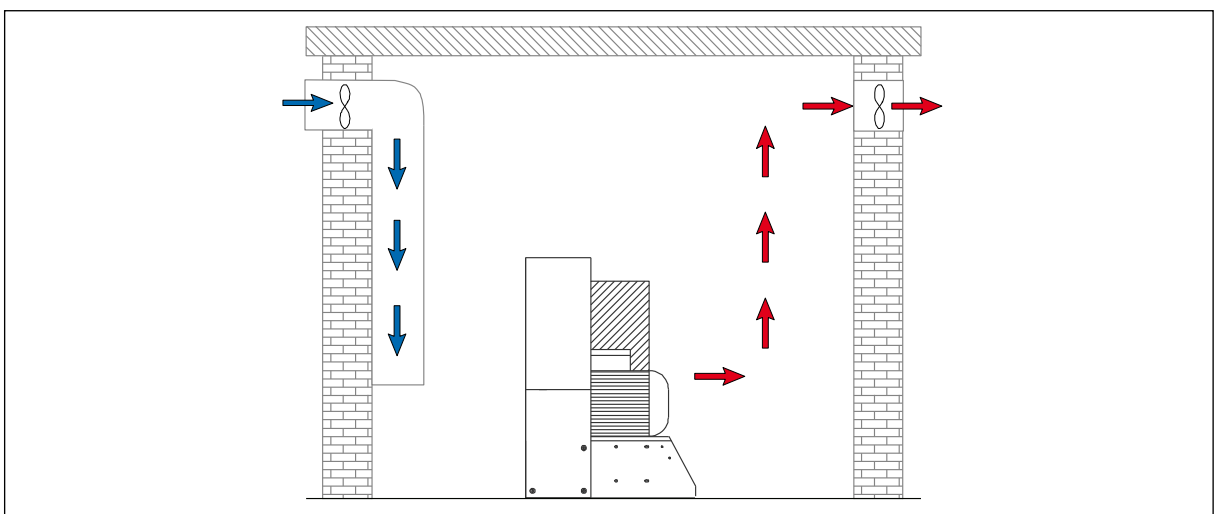

Fig. Ventilation via ventilation stack

INSTALLATION

Electrical Installation



Warning

Work on the electrical equipment on / with the machine / unit may only be carried out by qualified electricians.

For installation of electrical equipment, observe the following:

- If control devices are delivered by the factory, refer to the appropriate wiring diagram.
- Ensure correct installation of protective conductors.
- Check conformity of motor and control device tension and frequency with those of the electric network (see name plate on the compressor).
- The fusing should be done in accordance with the valid regulations of the responsible electricity supply company.
- When connecting the unit to the electrical supply, check the compressor direction of rotation (see chapter "Maintenance" -> Check turning direction).
- Fuse the motor correctly (see table; use slow-blow fuses).

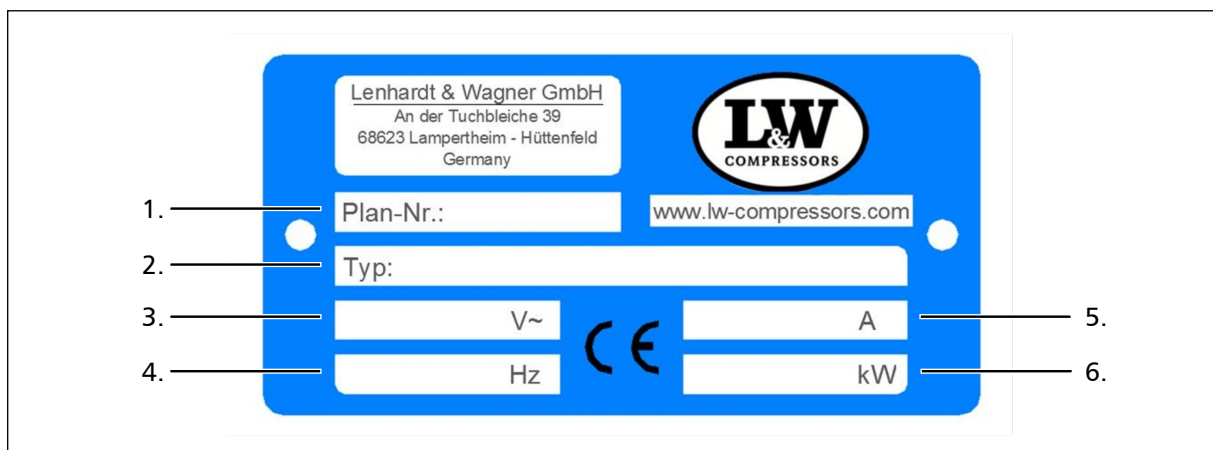

Fig. Compressor name plate

No.	Designation
1.	Circuit diagram number
2.	Compressor type
3.	Power supply
4.	Frequency
5.	Motor current consumption
6.	Nominal motor power

INSTALLATION

Electrical Installation

The standard compressor version is prepared for the connection to three phases (brown, black, grey), neutral conductor (blue) and protective earth conductor (green/yellow).

Fig. - Connection to the switch box

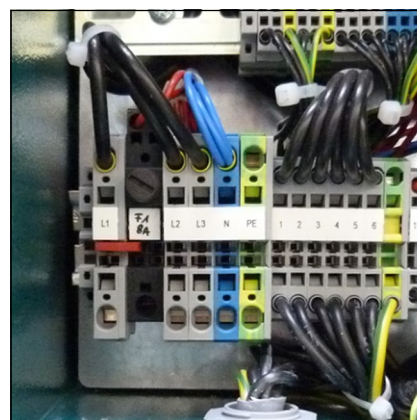

A

Recommended fuses for 360 - 500 V operating voltage

Nominal motor power		Fusing start A		Connection in mm ²	
[kw]	[A]	Direct	Star/Delta	Contactor supply	Motor S/D
18.5	36	-	50	6	4
22	41	-	50	10	4
30	55	-	63	10	6
37	68	100	80	16	6

Recommended fuses for 220 - 240 V operating voltage

Nominal motor power		Fusing start A		Connection in mm ²	
[kw]	[A]	Direct	Star/Delta	Contactor supply	Motor S/D
18.5	63	-	80	16	6
22	71	-	80	16	6
30	96	-	125	25	10
37	117	200	160	35	16



A

OPERATION

OPERATION

Important operation instructions



Note

Ensure that all persons handling the compressor are familiar with function and operation of the unit.



Wear hearing protection

When working on a running machine, always wear hearing protection.

A

FIRST COMMISSIONING

A

Prior to first commissioning, observe the following:

Necessary steps are described on the next page.

- Ensure that cooling air can flow freely.
- Check compressor oil level by the oil sight glass (see next page).
- Check all connections and retighten if necessary.
- Check if the filter cartridge is in place (see "Service and Maintenance").
- Check the V-belt tension (see next page).
- The compressor is delivered as standard with HP outlet!

Caution: When optionally equipped with an external filling panel, ensure that all lever filling valves are closed. Hold tight one filling valve manually and open the corresponding lever filling valve!

Start the compressor

1. Start the compressor by pushing the ON button.
2. Check turning direction - see the rotary direction arrow on the housing of the electric motor (see next pages). If the turning direction is wrong, immediately stop the compressor by pushing the OFF button and contact an authorised electrician.



Warning

Wrong impeller rotation direction!

Immediately after switching the compressor on, check the rotation direction. Depending on the place of installation, the phase sequence can influence the rotation direction.

3. Check oil pressure.
4. Run the compressor for about 2 minutes.
5. Caution: When optionally equipped with an external filling panel, close the opened lever filling valve carefully!
6. Run the compressor up to maximum pressure and check if the final pressure switch shuts off the compressor. If the final pressure switch does not shut off, switch off the compressor with the OFF button (see chapter "REMEDYING FAULTS").
7. Check the compressor unit for leaks (see "SERVICE AND MAINTENANCE")
8. Now check the condensate drain valves:
 - Fix the black condensate hoses
 - Drain test - press the test button
 - If correct, air escapes
9. Stop the compressor by pushing the OFF button.
10. Open all lever filling valves carefully to vent the air completely. (at the external filling panel)

FIRST COMMISSIONING

Check oil level



Warning

Check oil level daily. Never start the compressor with a too low oil level. Risk of accidental loss, destruction or deterioration.

Check oil before each operation of the system!

The oil level should be between the middle and upper end of the oil sight glass. Never start the compressor with a too low oil level.

Refill new compressor oil at least when the oil level reached the middle of the indicated area.

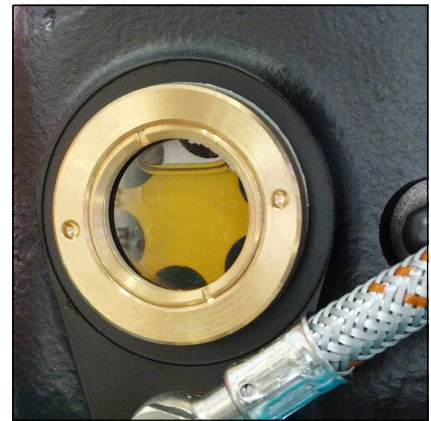

Oil sight glass

Check V-belt tension

The V-belt could lose tension during transportation. Please check the V-belt tension before starting the compressor.

Tension V-belt / Correct V-belt tension

See chapter "Service and Maintenance" -> "Tension V-belts"

FIRST COMMISSIONING

Check turning direction



Warning

Wrong impeller rotation direction!

Immediately after switching the compressor on, check rotation direction. Depending on the place of installation, the phase sequence can influence the rotation direction.

Before starting the compressor for the first time, check rotation direction (see the rotary direction arrow on the housing of the electric motor and the protective cover fan).

If the direction of rotation is wrong, the guide pistons of the 2nd and 3rd stages can not be sufficiently lubricated, with the consequence that the pistons will be damaged. Furthermore, cooling air flow will not be sufficient.



Fig. 1 - Rotary direction arrow (motor)

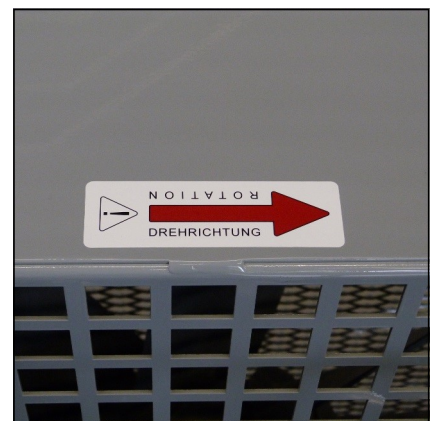

Fig. 2 - Rotary direction arrow
(protective fan cover)



DAILY COMMISSIONING

Prior to daily operation observe the following:

- Ensure cooling air can flow freely.
- Check compressor oil level by the oil sight glass.
- Check if filter cartridge is in place / observe filter cartridge life!

A

OPERATION

Filling procedure



Caution! Fill only cylinders which:

- are marked with the test mark and the test stamp of the expert.
- have been hydrostatic tested (check last test date).
- are rated for the final pressure.
- are free from humidity.



Note

The unit shuts down when final pressure is reached. Thus, the unit always has to be restarted manually.

1. Close all filling valves.
2. Connect the closed compressed air cylinders.
3. Open cylinder valves.
4. Start compressor by pushing the ON button.
5. When the filling pressure gauge increases, open the filling valves slowly.
6. Fill compressed air cylinders to the desired pressure, subsequently close the filling valves slowly.
7. Close and vent all filling valves.
8. Disconnect all compressed air cylinders from filling valves.

OPERATION

Switch off the compressor

The compressor unit is equipped as standard with a pressure switch which automatically shuts down the system when the corresponding final pressure is reached.

During filling process, you can shut down the system at any time by pushing the red button (OFF) or the emergency stop (only in case of emergency!).



Note

After automatic or manual switching off, all pressure vessels and filter housings of the compressor will be automatically vented.

OPERATION

Interstage pressure gauges

Each of the 4 pressure stages is monitored by a single pressure gauge. This is serviceable for troubleshooting and allows detecting faults at an early stage.

Indicated interstage pressures depend on final pressure settings.

The pressure gauges should show the following values at a final pressure of 300 bar:

1st stage: approx. 4.2 bar (g)

2nd stage: approx. 17 bar (g)

3rd stage: approx. 70 bar (g)

4th stage: approx. end pressure

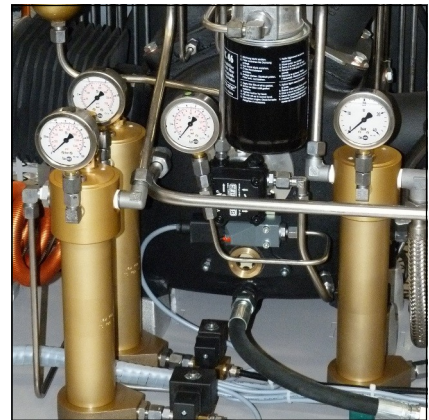

Fig. 1 - Interstage pressure gauges



Fig. 2 - Interstage pressure gauges in SILENT HOUSING

A

OPERATION

Oil pressure gauge and oil distributor block gauge

The oil pressure gauge shows the compressor oil pressure during operation. Oil pressure values should remain between:

- min. + 2.3 bar
- max. + 4.0 bar

If oil pressure value stays below the minimum value:

- Wrong compressor rotation direction (see rotation direction arrow)
- Oil level too low, not enough oil in the compressor
- Oil pump sieve contaminated
- Oil intake hose damaged / defective
- Oil temperature below +5 °C - lubrication not possible
- Oil temperature higher than +120 °C - oil viscosity too low
- Oil pump defective

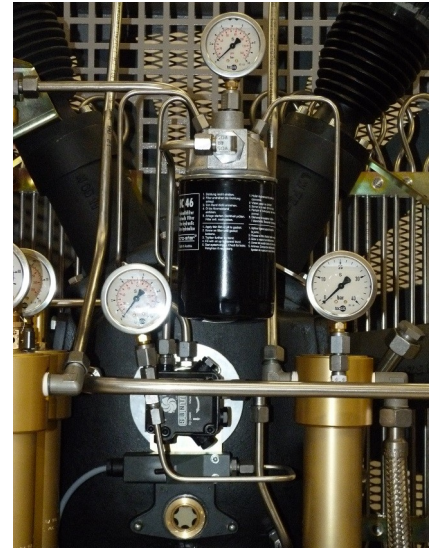

Oil pressure gauge and oil distributor block gauge

If oil pressure value stays above the maximum value:

- Low oil temperature, between +5 °C and +10 °C
- Should stay within the range of tolerance when operation temperature is reached..

Oil pressure control

If oil pressure remains outside the range of tolerance, it can be adjusted at the oil pump.

Increasing oil pressure

- Turn adjusting screw clockwise

Reduce oil pressure

- Turn adjusting screw anti-clockwise

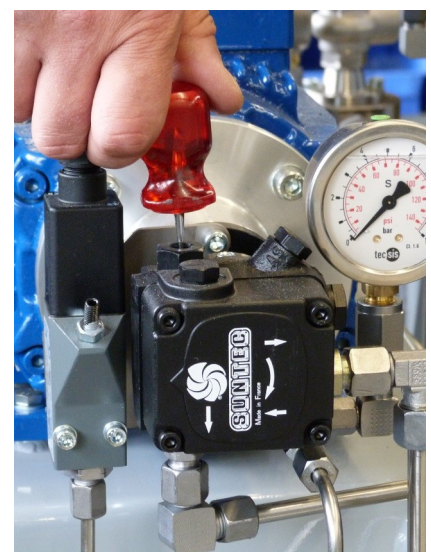

Adjusting the oil pressure

OPERATION

Oil pressure monitoring

The oil pressure is maintained by a pressure switch during operation. The compressor automatically shuts off when oil pressure decreases below the minimum pressure of +2.0 bar. The red warning lamp "Oil Pressure Monitoring" lights up.

Possible causes of fault:

- Wrong compressor rotation direction
(see rotation direction arrow)
- Oil level too low, not enough oil in the compressor
- Oil pump sieve contaminated
- Oil intake hose damaged / defective
- Oil temperature below +5 °C - lubrication not possible
- Oil temperature higher than +120 °C - oil viscosity too low
- Oil pump defective



Oil Pressure Monitoring

A



A

REMEDYING FAULTS

REMEDYING FAULTS

Final pressure can not be reached

Cause of fault	Remedy
Connections leaky	Retighten or clean/replace if necessary
Final pressure safety valve leaky	Replace
Pipes / heat exchanger broken	Replace
Condensate drain valves leaky	Unscrew valves, check sealing surfaces, clean, replace if necessary
Final pressure switch stop unit	Verify settings, replace if necessary
Piston of pneumatic condensate valve sticks	Clean pneumatic condensate valve and restore function, check/replace o-rings, replace valve completely if necessary

Strong compressor vibration

Cause of fault	Remedy
V-belt tension too loose	Tension V-belt
Drive motor / Compressor unit loosely	Retighten mounting screws
Anti vibration mounts used up	Replace
Ground not levelled	Ensure a solid and level ground

Air supply too low

Cause of fault	Remedy
Inlet and outlet valves contaminated / defective	Clean, replace if necessary
Cylinder(s), piston(s) or piston ring(s) used up	Replace
V-belt slips	Tension V-belt
See chapter "Final pressure can not be reached"	See chapter "Final pressure can not be reached"

REMEDYING FAULTS

Compressor overheated

Cause of fault	Remedy
Inlet filter cartridge contaminated	Replace
Ambient temperature too high	Improve room ventilation / Reduce operation times
Cooling air inlet and outlet insufficient	Observe minimum distances (see Installation Instructions)
Intake hose too long	Reduce length of the air intake hose
Intake hose diameter too small	Use a larger diameter
Wrong compressor rotation direction	Ensure correct phase rotation, observe rotation direction arrow!
Inlet and outlet valves contaminated / defective	Clean, replace if necessary

Safety valve leaks

Cause of fault	Remedy
Inlet and outlet valves of the following pressure stage defective	Clean, replace if necessary
Sinter filter of the following water separator blocked	Replace
Safety valve leaky	Replace

Oil Taste in the Air

Cause of fault	Remedy
Mole carbon filter cartridge saturated	Replace
Compressor oil unsuitable	Use prescribed oil quality
Filter cartridge unsuitable	Use prescribed filter type
Cylinder(s), piston(s) or piston ring(s) defective	Replace

REMEDYING FAULTS

Automatic condensate drain defective

Cause of fault	Remedy
Solenoid coils defective	Replace
Cable / supply cable defective	Repair, replace if necessary
Timer / relais defective	Replace
Sinter filter of pneumatic condensate valve blocked	Replace
Piston of pneumatic condensate valve sticks	Clean pneumatic condensate valve and restore function, check/replace o-rings, replace valve complete if necessary

Condensate drain starts before reaching final pressure

Cause of fault	Remedy
Pressure stages are not as prescribed, control pressure of pneumatic condensate valve too low	Check corresponding inlet and outlet valve, replace if necessary.
Piston sealing of pneumatic condensate valve contaminated / used up	Clean, replace if necessary
Timer / relais settings not correct	Adjust as prescribed
Timer / relais defective	Replace

Compressor stops before final pressure

Cause of fault	Remedy
Final pressure switch settings not correct	Correct settings
Opening pressure of the pressure maintaining valve too high	Correct settings
Fuse / circuit breaker has tripped Valid only for E models	Check fusing of the power supply / observe regulations
Emergency stop switch has tripped	Unlock emergency stop switch, close compressor housing door correctly

REMEDYING FAULTS

Filter life not sufficient

Cause of fault	Remedy
Pressure maintaining valve settings not correct	Adjust as prescribed
Filter cartridge unsuitable	Replace by a prescribed filter cartridge type
Filter cartridge too old	Observe expiration date
Filter cartridge packaging incorrect / damaged / already opened. Filter cartridge already partly saturated before change	Store filter cartridges properly, dispose defective cartridges
Operating temperature too high	Ensure sufficient ventilation
Cylinder(s), piston(s) or piston ring(s) defective	Replace

Oil consumption too high

Cause of fault	Remedy
Cylinder(s), piston(s) or piston ring(s) defective	Replace
Compressor oil unsuitable	Use prescribed oil quality
Operating temperature too high	Observe prescribed operating temperatures
Oil leak at the compressor block	Tighten corresponding mounting screws, if necessary replace corresponding paper sealing / o-ring / shaft seal



A

MAINTENANCE AND SERVICE

MAINTENANCE AND SERVICE

Service, Repair and Maintenance

Carry out service and maintenance work exclusively when the compressor is stopped and depressurised. The unit should be leak-checked regularly. Leaks can be preferably localised by using a leak detector spray (if necessary, brush pipes with soapy water).

We recommend that only authorised L&W service technicians carry out service work on the bearing of the compressor (crankshaft and connecting rods).

We urgently recommend that all maintenance, repair and installation work must only be carried out by trained personnel. This is necessary because all maintenance work can not be explained exactly and detailed in this manual.

Only use authentic spare parts for service work.



Danger

Components under pressure, such as hose ends, can quickly come loose when manipulated and can cause potentially fatal injuries due to the pressure surge. Any work on system parts may only be performed in a pressure-compensated state.



Warning

The use of accessories that have not been tested can lead to death or serious injury or damage to the unit. Only use authentic spare parts for service work.



Warning

Carry out maintenance or service work when the unit is switched off and protected against unexpected restart.



Warning

Risk of burns!

Carry out maintenance or service work when the unit has cooled down.



MAINTENANCE AND SERVICE

Daily before taking unit into operation

Maintenance work	Type	Quantity	Order No.
Check oil level	-	-	000001
Check condition of all filling hoses	-	-	-
Check filter cartridge lifetime	-	-	-
Operate unit to final pressure and check function of final pressure switch	-	-	-
Open manual drain valves of 2.3ltr filter housings	-	-	-

At 25 operating hours

Maintenance work	Type	Quantity	Order No.
Oil change	-	5.5	000001
Replace oil filter	-	1	003928

Every 3 months or as required

Maintenance work	Type	Quantity	Order No.
Check automatic condensate drain, open manual condensate taps	-	-	-
Check/Retorque all connections and bolts	-	-	-



MAINTENANCE AND SERVICE

Annually

Maintenance work	Type	Quantity	Order No.
Oil change, if less than 1000 operating hours	-	5.5	000001
Check V-belt tension and condition	-	3	001412
Check opening pressure of final safety valve	-	-	-
Clean coolers	-	-	-
Clean all oil/water separators, if less than 500 operating hours	-	-	-
Service intake filter (depends on condition - if less than 500 operating hours)	-	-	-
Check all connections for leakage	-	-	-

Every 500 operating hours

Maintenance work	Type	Quantity	Order No.
Clean intake filter	-	1	000170
Check pressure maintaining/non-return valve	-	-	-
Check V-belt tension and condition	-	-	-



MAINTENANCE AND SERVICE

Every 1000 operating hours

A

Maintenance work	Type	Quantity	Order No.
Replace o-rings of intake filter housing	-	1	001300
Replace intake filter	-	1	000170
Replace sintered metal filter of oil/water separators	1 / 2 / 3 stage	3	000173
	1 / 2 / 3 stage	3	002914
Replace o-rings of oil/water separators	1 / 2 / 3 stage	9	001272
	4th stage	2	001294
Replace silencer	-	1	000178
Replace sintered metal filter of oil/water separators	4th stage	2	000184
Replace sintered metal filter of pneumatic condensate valve	-	1	000188
Replace oil sieve and oil pump cover gasket	-	1	002569
Oil change	-	5.5	000001
Replace oil filter	-	1	003928
Replace o-rings of the final filter housing	-	4	001287
Replace back-up rings of the final filter housing	-	4	001285
Replace o-rings of filter housing (0.8 litre)	-	1	004221
Replace filter element of filter housing (0.8 litre)	-	1	003980
Replace back-up ring of the filter housing (0.8litre)	-	1	004222



MAINTENANCE AND SERVICE

Every 2000 operating hours

Maintenance work	Type	Quantity	Order No.
Replace all inlet and outlet valves incl. gaskets	1st stage	1	000369
	2nd stage	1	000256
	3rd stage	1	000549
	4th stage	1	000550
	Upper gasket 1st	1	000349
	Upper gasket 2nd	1	000254
	Lower gasket 1st	1	002901
	Lower gasket 2nd	1	003046

Every 4000 operating hours (Latest in 10 years)

Maintenance work	Type	Quantity	Order No.
Replace all o-rings and gaskets of 1st, 2nd, 3rd and 4th stage	o-ring	4	010785
	o-ring	2	001296
Replace shaft seal	-	1	010175
		1	010176
Replace needle bearings for conrod 2nd, 3rd and 4th stage	2nd stage	1	003281
	3rd / 4th stage	4	006698

A



MAINTENANCE AND SERVICE

Check V-belt tension

The V-belts could lose tension during transportation. Please check the V-belt tension before starting the compressor.

A

Tension V-belts

To tighten V-belt tension, loosen 4 mounting nuts of the drive motor. Use the tensioning screw to move the electric motor until the V-belt tension is sufficient. Then, tighten mounting nuts and check V-belt tension.

We recommend using a V-belt tension gauge.

Correct V-belt tension

Do not tension V-belts too tight. This damages bearings of compressor and motor. The V-belts should only be tensioned until there is no noise caused by slipping during start.

Settings

Motor Type	Initial Installation	Operation after running in
Electric motors 50Hz	600 N	450 N
Electric motors 60Hz	500 N	400 N

MAINTENANCE AND SERVICE

Compressor lubrication

Crankshaft bearings of the 1st and 2nd stage get lubrication by an oil slinger. In addition, 1st and 2nd stage are lubricated by spray oil. The 3rd and 4th stage are lubricated by a mechanical oil pump.

A

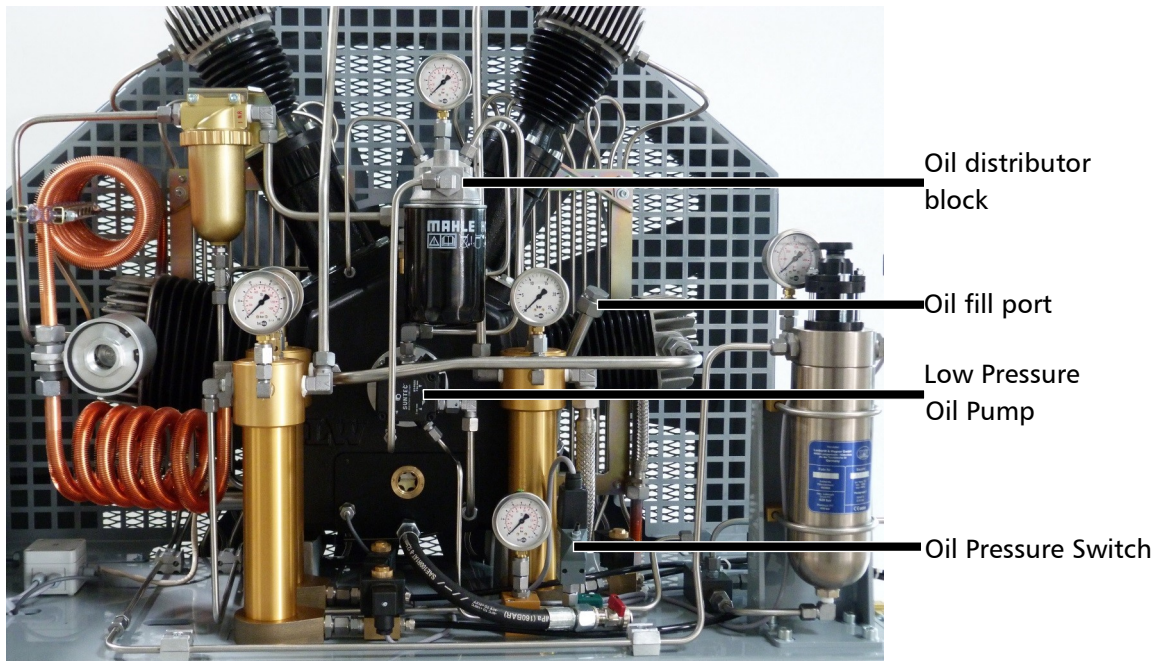

Lubricating System

Check oil level



Warning

Check oil level daily. Never start the compressor with a too low oil level. Risk of accidental loss, destruction or deterioration.

Check oil before each operation of the system!

The oil level should be between the middle and upper end of the oil sight glass. Never start the compressor with a too low oil level.

Refill new compressor oil at least when the oil level reached the middle of the indicated area.

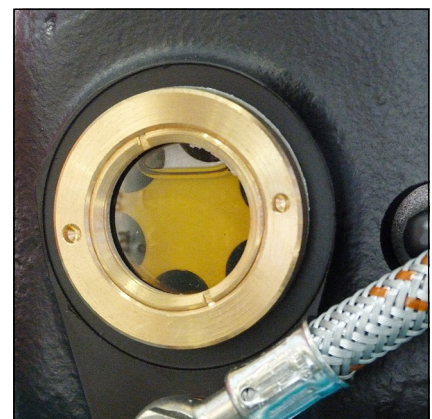

Oil sight glass

Oil change



Note

We recommend oil change at least once a year - depending on total operating hours.

A

Oil change as follows:

- Run compressor warm for approx. 2 min.
- Switch off and vent compressor.
- Place a suitable oil drain tray under the drain hose.
- Open carefully oil drain valve and drain oil completely.
- Close oil drain valve.
- Change oil filter cartridge with a suitable oil filter key.
Pre-fill the new oil filter cartridge with synthetic compressor oil.
- Loosen oil fill port with an appropriate adjustable wrench (AF 0-40 mm) and unscrew manually.
- Fill oil by using a funnel.
- Check oil level. The oil level should be between the middle and upper end of the oil sight glass.
- Screw oil fill port manually in and tighten with the adjustable wrench.

The oil-/oil filter change is now completed.

Maintenance intervals

- First oil-/ oil filter change after 25 operating hours (total hours).
- All further changes after each 1,000 operating hours.

Oil and oil capacity

Approx. 4,200 ml synthetic compressor oil is necessary for one oil change. Only use synthetic compressor oil which is recommended as suitable from L&W.

MAINTENANCE AND SERVICE

A

Oil sieve change

Oil sieve change as follows:

- Loosen cover screws (4 pcs).
- Remove the cover, the cover gasket and the oil sieve.
- Clean the oil sieve with petroleum-ether or replace the defective oil sieve.
- Replace the gaskets.
- Soak the gaskets with oil before placing (respect mounting direction).
- Be sure to position the arrow (see Fig., Pos. 1) from the new oil sieve opposite to inlet and return ports of the pump (see Fig., Pos. 2).
- Remount the cover with the 4 cover screws. Tightening torque: 4.5 - 8 N.

The oil sieve change is now completed.

Maintenance intervals

- We recommend cleaning or replacing the oil sieve every 1,000 working hours.
- 009545 - Oil sieve, 009546 - oil pump cover gasket

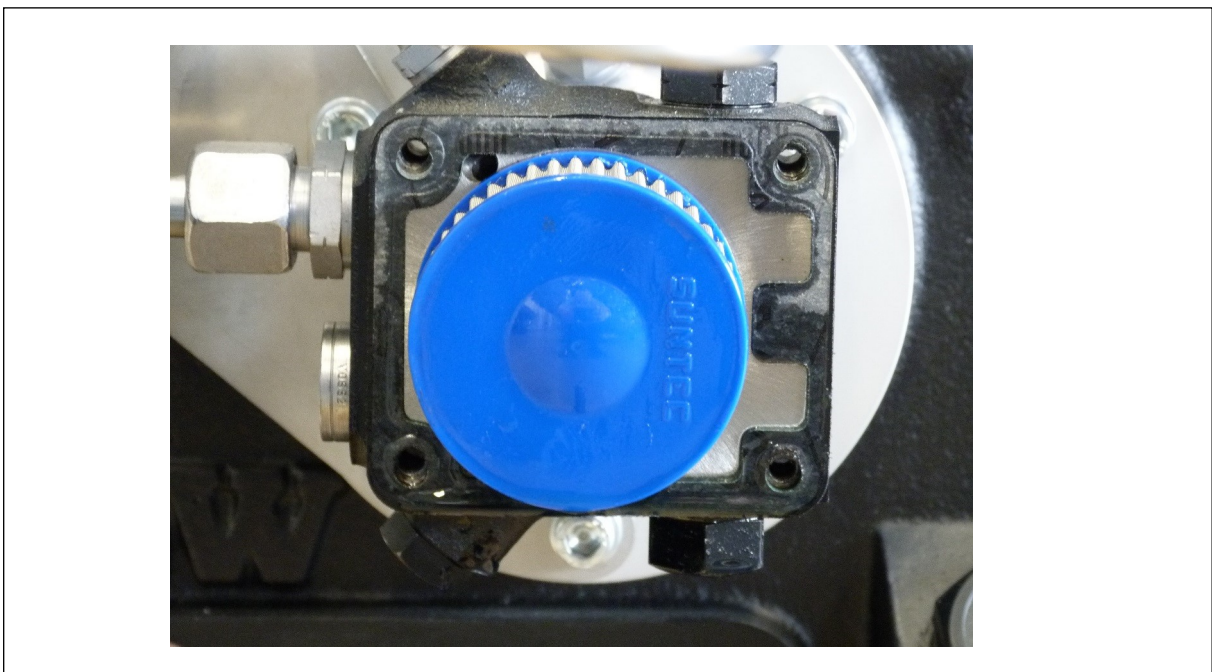

Correct oil sieve mounting direction

Final pressure switch



Note

Do not adjust the final pressure switch to the safety valve pressure. The final pressure switch has to be adjusted to min. 10 bar below the safety valve pressure. Otherwise, the safety valve can open during operation. This considerably reduces the life of the safety valve.

The pressure switch shuts off the compressor automatically when the selected final pressure is reached. The final pressure switch is already adjusted to the corresponding cut-out pressure.

The pressure can be adjusted with the upper adjusting screw as follows:

Increasing cut-out pressure:

Turn the adjusting screw clockwise

Reducing cut-out pressure:

Turn the adjusting screw anti-clockwise

Adjust the pressure switch in steps of a quarter turn. Restart the compressor after every adjustment step to verify the actual cut-out pressure.

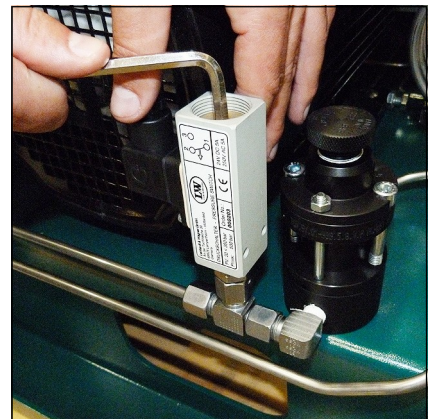

Final pressure switch

Example settings:

Safety valve	Max. Operating Pressure
225 bar	215 bar
250 bar	240 bar
330 bar	320 bar
330 bar	320 bar
365 bar	350 bar
420 bar	400 bar
450 bar	420 bar

Automatic condensation dump system



Note

The collected condensate can contain oil and has to be disposed according to regulations.

The LW 720 E comes as standard with an automatic condensation dump system. Solenoids drain all condensate separators every 15 minutes.

To test the system, press the blue condensate test drain button on the operating panel.

Oil / water separators

Condensate is separated after every stage of compression. All four oil / water separators are equipped with electronic timer controlled solenoids. The timer is located in the switch box and activates the dump valves about every 15 minutes.

To release the complete condensate through the black plastic hoses, we recommend using an 60 l container at least.

The drain noise can be kept to a minimum by using a silencer.



Oil / water separators 1st, 2nd and 3rd stage

Maintenance intervals

We recommend to clean oil and water separators every 500 operating hours or at least once a year, to check for corrosion damage and to replace o-rings if necessary.

All oil / water separators have an integrated sinter filter which has to be replaced every 1,000 operating hours.



Oil / water separators final stage

MAINTENANCE AND SERVICE

Oil / water separators 1st, 2nd and 3rd stage - maintenance



Note

Clean all parts thoroughly before assembly. The figures of the parts can differ due to the different stages.

Maintenance / cleaning of oil / water separators as follows:

- Loosen pipe connections and mounting screws.
- Remove oil / water separators.
- Unscrew and remove filter top.
- Open nut and remove separator top (Fig. 1).
- Change sinter filter (Fig. 2).
- Reassemble all parts and tighten nut.
- Change o-ring, previously grease new o-ring (Fig. 3).
- Place separator top and tighten manually.
- Remove bottom part (Fig. 4)
- Change o-ring, previously grease new o-ring
- Press in bottom part
- Mount oil / water separators.
- Change sinter filter which is sitting between oil/water separator housing and condensate drain outlet connection. (Fig. 5)
- Tighten pipe connections and mounting screws.

The oil / water separator maintenance is now completed.

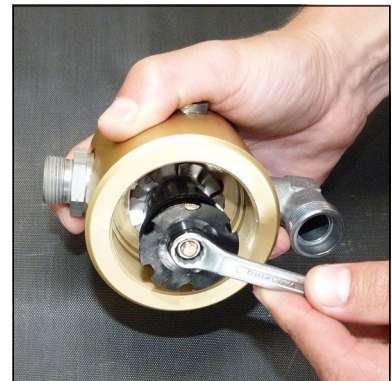

Fig. 1 - Loosen nut at the separator top

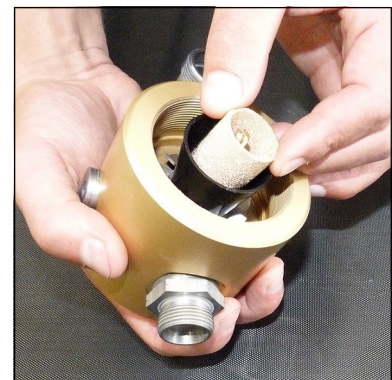

Fig. 2 - Change sinter filter

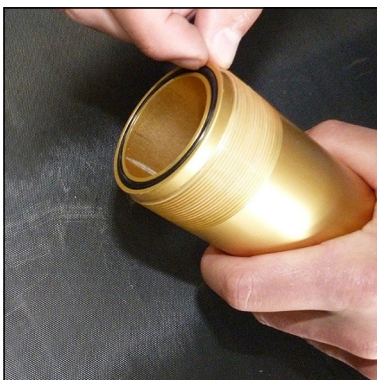

Fig. 3 - Change o-ring



Fig. 4 - Bottom part

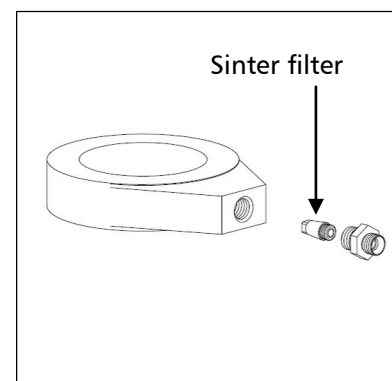

Fig. 5 - Sinter filter

MAINTENANCE AND SERVICE

Oil / water separators final stage - maintenance



Note

Clean all parts thoroughly before assembly.

Change/clean oil / water separators final stage as follows:

- Loosen pipe connections and mounting screws.
- Remove oil / water separators.
- Open ring nut and remove separator top (Fig. 1).
- Loosen nut at the separator top.
- Change sinter filter (Fig. 2).
- Reassemble all parts and tighten nut.
- Change o-ring, previously grease new o-ring (Fig. 3).
- Place separator top and tighten ring nut manually.
- Replace silencer.
- Mount oil / water separators.
- Tighten pipe connections and mounting screws.

The oil / water separator maintenance is now completed.

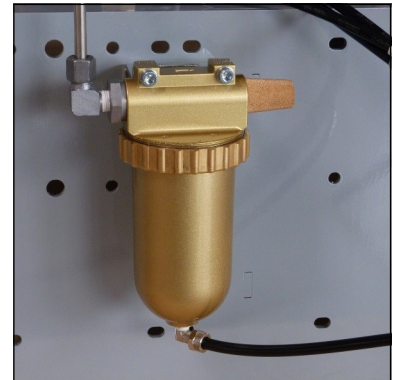

Oil / water separators final stage



Fig. 1 - Loosen ring nut

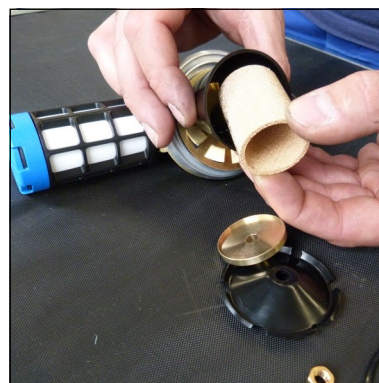

Fig. 2 - Change sinter filter



Fig. 3 - Change o-ring

MAINTENANCE AND SERVICE

Filter element change 0.8ltr filter housing

Filter element change as follows:

- Start the compressor and run up to a pressure of 100 bar.
- Stop the compressor.
- Open the filling valve.
- Loosen pipe connections and mounting screws (Fig. 1 a. 2)
- Remove complete filter housing.
- Open filter cover (Fig. 3).
- Change the filter element (stuck in filter cover) (Fig. 4).
- Change o-ring, previously grease new o-ring .
- Grease thread of filter cover, o-ring and back-up ring.
- Reassemble filter cover and filter housing. Note the correct position of th filter back-up!
- After you have screwed it completely, loosen the filter cover about 90 °. This avoids a terminals of the filter cover due to a hard shaking while operation.

The filter cartridge change is now completed.



Note

Ensure that the old filter element is disposed correctly at an approved waste point.



Fig. 1 - Loosen pipe connections and mounting screws

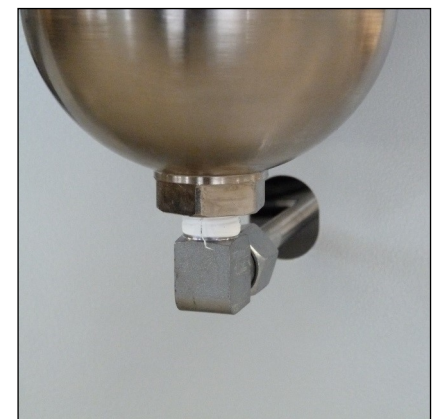

Fig. 2 - Loosen pipe connections and mounting screws

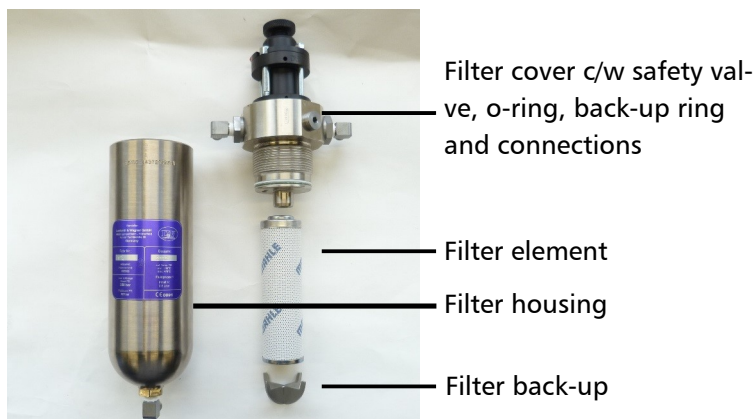

Fig. 4 - 0.8ltr Filter housing parts



Fig. 3 - Open filter cover

Pneumatic condensate valve - maintenance



Note

Clean all parts thoroughly before assembly.

Pneumatic condensate valve change as follows:

- Loosen pipe connections and mounting screws.
- Remove pneumatic condensate valve.
- Loosen connection (Fig. 2).
- Change sinter filter (Fig. 3).
- Tighten horizontal screw.
- Mount pneumatic condensate valve.
- Tighten pipe connections and mounting screws.

Pneumatic condensate valve maintenance is now completed.

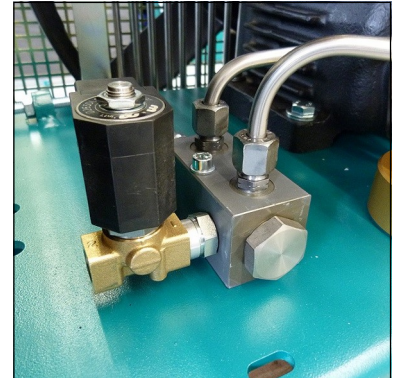

Pneumatic Condensate Valve

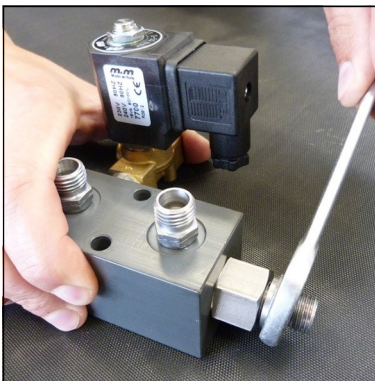

Fig. 2 - Loosen connection

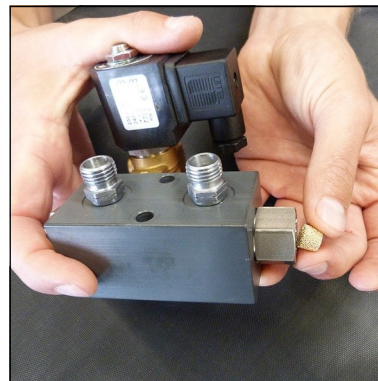

Fig. 3 - Change sinter filter

MAINTENANCE AND SERVICE

Filter housings

The mole carbon filter housings are completely fitted to the compressor. Inside the filter housing a jet blows air on to the housing wall. Condensation water and oil are led by centrifugal force to the bottom of the housing. Air flows through the mole carbon filter cartridge, which purifies the air from residual moisture and odours. The black condensate drain valves needs to be opened dailey to drain the water.



Warning

Open valve spindle max. 1.5 turns.

The pressure in the housing can shoot out the valve spindles at high speed.

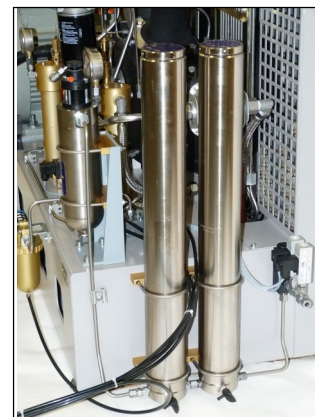

Filter panel

A

Filter cartridge

The high-pressure compressor is equipped with an integrated breathing air purification system. Air is compressed up to 330 bar, dried and odour- and tasteless purified. Oil residues are bounded. The breathing air filter cartridge consists of a molecular sieve and activated-carbon filter.

Cartridge capacity: approx. 2.3 l

All breathing air filter cartridges are factory vacuum sealed.

We recommend unpacking the filter cartridges just before installation. Filter cartridges which are exposed too long could be saturated with moisture and become unusable.

P/N	Filtering	Models
000003	DIN EN 12021 (Breathing Air)	For models with 2.3 ltr Filter housings
001461	DIN EN 12021 (Breathing Air) incl. CO/CO2	For models with 2.3 ltr Filter housings
001467	Only oil / odour removal (<0,1mg/m ³)	For models with 2.3 ltr Filter housings
001462	Only drying (<15mg/m ³)	For models with 2.3 ltr Filter housings
001468	CNG filter (drying and oil removal)	For models with 2.3 ltr Filter housings

Maintenance intervals

Filter cartridges should be changed at the following intervals, at +20°C or more often, depending on humidity and ambient temperature: 56 hours

MAINTENANCE AND SERVICE

Filter cartridge change

Filter cartridge change as follows:

- Run the compressor up to a pressure of 100 bar.
- Stop compressor.
- Open filling valve.
- Unscrew filter housing cover by using the special filter tool (Fig. 1).
- Place the T-piece end of the filter tool in the recess of the filter cartridge (Fig. 2).
- Unscrew the filter cartridge anti-clockwise and pull the cartridge out of the housing (Fig. 3).
- Open the packing of the new filter cartridge and place it with the filter tool in the filter housing.
- Screw the new filter cartridge hand tight in by using the filter tool.
- Screw the cover of the filter housing first manually in.
- After it has been completely screwed in, turn cover anticlockwise for 90°. This avoids tightening of the cover due to vibration..

The filter cartridge change is now completed.



Note

Ensure that the old filter cartridge is disposed correctly at an approved waste point.



Fig. 1 - Unscrew the filter housing cover.



Fig. 2 - Place the T-piece end of the filter key in the top of the filter cartridge.



Fig. 3 - Pull the cartridge out of the housing.

A

Filter housing - maintenance



Note

Clean all parts thoroughly before assembly.

Filter housing maintenance as follows:

- Open Filter Cover (Fig. 1).
- Change o-ring and back-up ring, previously grease both (Fig. 2).
- Grease filter cover thread and close.

Dismount filter housing

- Loosen u-clamps and pipe connections and nuts (Fig. 3).
- Remove filter housing.
- Dismount filter housing base.
- Change o-ring and back-up ring, previously grease both (Fig. 4).
- Screw filter base tight in.

Mount filter housing

- Connect pipe connections and tighten.
- Adjust u-clamps and tighten nuts.

The filter housing maintenance is now completed.



Fig. 1 - Open Filter cover



Fig. 2 - Change o-ring and back-up rings



Fig. 3 - Loosen u-clamps and pipe connections



Fig. 4 - Change o-ring and back-up rings

Inlet filters

Note
 Dirty filters make intaking air difficult and reduce delivery capacity. Risk of compressor overheating.

A micro filter cartridge is used as an air inlet filter. Check air inlet filter regularly or replace it. Defective air inlet filters should be immediately replaced with a corresponding filter.

Maintenance intervals

We recommend that the filter cartridge should be replaced every 1,000 working hours (depending on pollution grade).

Inlet filter cartridge change

Inlet filter cartridge change as follows:

- Loosen cover.
- Change inlet filter cartridge and o-ring.
- Refit cover.

The inlet filter cartridge change is now completed.

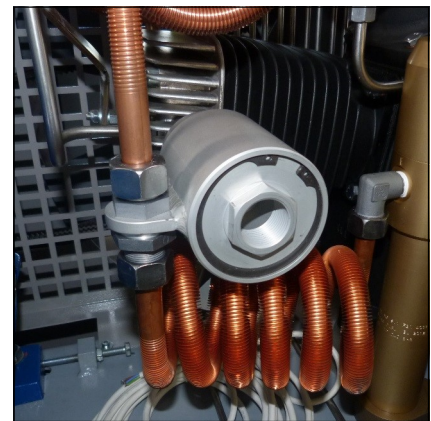

Air inlet filter housing

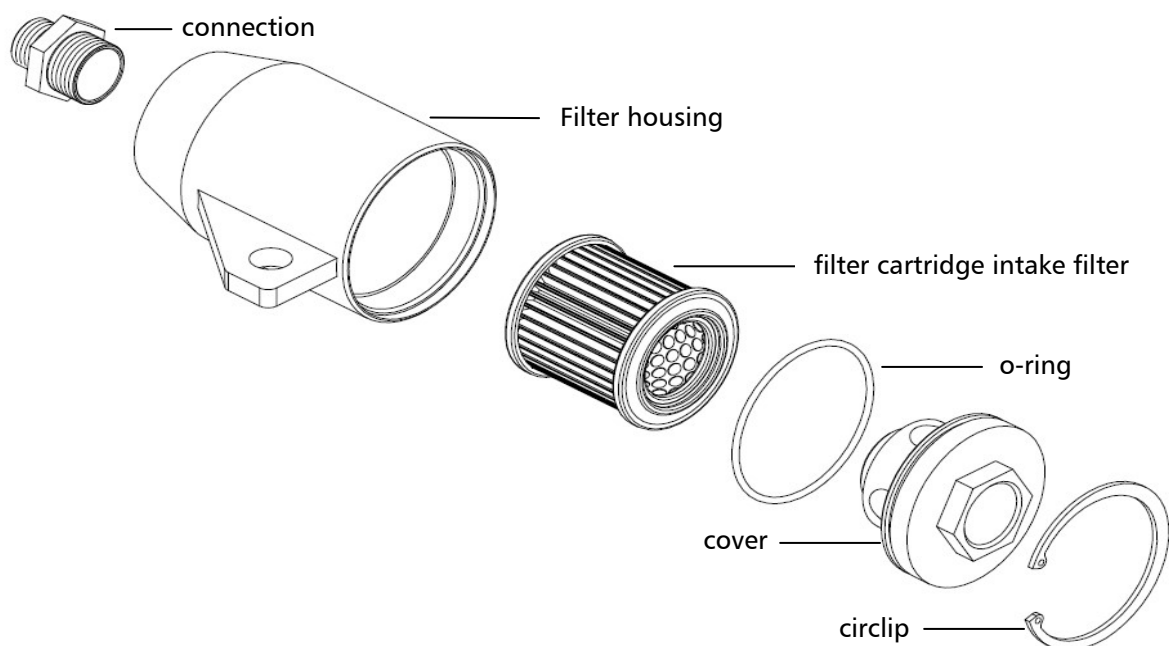

Inlet filter housing

MAINTENANCE AND SERVICE

Cylinder heads and valves

Inlet and outlet valves of the specific compressor stages are located between valve head and cylinder. Outlet valves open while piston downstroke, inlet valves open while upstroke or compression stroke.

Valves are subject to normal wear and tear and have to be replaced at certain intervals (depending on specific operating conditions). Dismount valve heads to change valves. All valves are combined inlet and outlet valves. The first and second stage valves are plate valves. The third and fourth stage contains a spring operated piston which acts inside a bronze cylinder.

Maintenance intervals

All valves should be replaced after 2,000 working hours due to normal wear and tear. To replace valves the cylinder heads have to be removed. There are no special tools required to replace these valves.

Important torque rates for bolts

Cylinder heads

Stage	Tightening torque	Thread
1st Stage	55 Nm	M10
2nd Stage	30 Nm	M8
3rd Stage	30 Nm	M8
4th Stage	30 Nm	M8

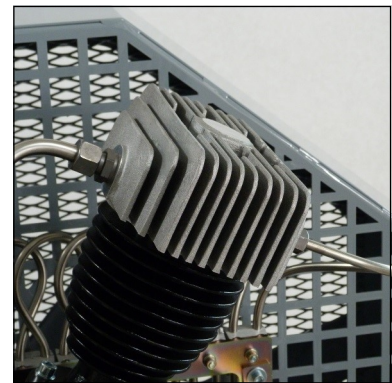

Zylinderkopf 3.Stufe

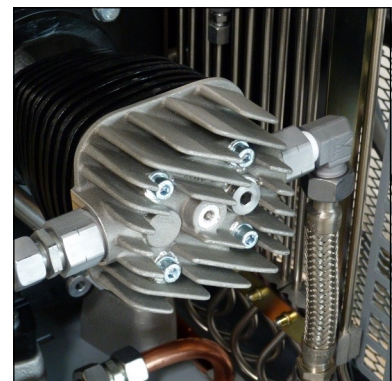

Zylinderkopf 2.Stufe

MAINTENANCE AND SERVICE

Safety valves

Every pressure stage is equipped with a separate over pressure safety valve. Safety Valves avoid a non permissible high pressure at the specific pressure stages and limit maximum operation pressure of the compressor.

Safety valves are adjusted to:

- 1st Stage: 8 bar
- 2nd Stage: 22 bar
- 3rd Stage: 90 bar
- 4th Stage: max. final pressure

The adjusted blow-off pressure [bar] of the safety valves is indicated on their housings.

All safety valves are factory sealed with special L&W safety seals to avoid manipulation of the limit value settings.

Safety valves with removed seals have to be immediately checked for the prescribed settings and replaced if necessary.

The safety valve of the final stage is furthermore equipped with a knurled screw to be activated once.

Turning the knurled screw clockwise could vent the valve completely and therefore the final filter housing.

During normal operation conditions, the knurled screw has to be turned anti-clockwise up to the upper stop. An integrated circlip avoids complete unscrewing.

If a safety valve blows off, it indicates problems with either inlet or outlet valve of the following stage.



Note

Replace defective safety valves immediately!

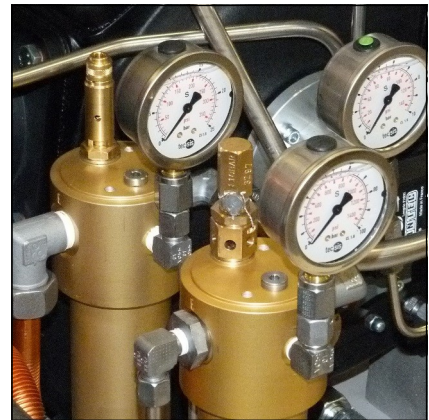

Safety valve 1st and 2nd stage

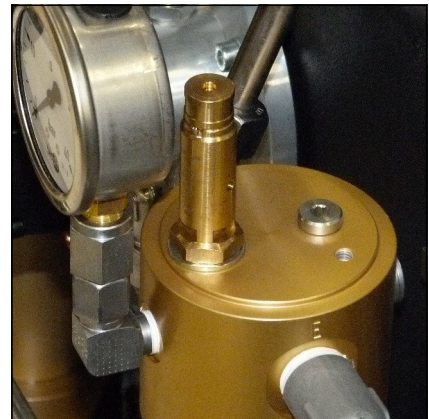

Safety valve 3rd stage



Safety valve 4th stage

A

Pressure maintaining / non return valve

**Note**

If the adjusted opening pressure of the pressure maintaining valve is higher than the final pressure of the compressor, the final pressure safety valve blows off before pressure maintaining valve opens (final pressure = 0 bar). When valve settings are not clear (e.g. after disassembly / repair), start the adjustment with a low basic setting (turn adjusting screw approx. 3 times in).

A pressure maintaining / non return valve is installed after the mole carbon filter housing. It maintains a pressure of at least 150 bar inside the filter housing - this optimises filter efficiency.

Pressure maintaining valve

The pressure maintaining valve drains a large part of the water content of the compressed air mechanically by ensuring the minimum outlet pressure. This guarantees optimal drying and purification of the breathing air.

After starting the compressor, the pressure inside the final filter housing constantly increases. The pressure maintaining valve prevents the compressed air from blowing off (final pressure gauge = 0 bar).

When the adjusted opening pressure is reached (150 and 180 bar), the purified compressed air flows via pressure maintaining and non return valve to the filling valve.

The value of the opening pressure of the pressure maintaining valve can be read at the final pressure gauge. When opening pressure is reached, the pressure gauge value increases within a few seconds.



Pressure maintaining/non-return valve

Safety valve test



Note

Do not fill any tank during test phase!

Safety valve test as follows:

- Disconnect compressor from the electrical power supply and protect against unexpected restart.
- Remove the cover of the switch box.
- Switch on the "Test Safety Valve" switch (pressure switch will be deactivated!).
- Mount the cover of the switch box.
- Connect the compressor to the electrical power supply.
- Close filling valves.
- Start the compressor.
- Watch the final pressure gauge. The safety valve should open when reaching working pressure of the compressor. If not, switch off the unit and take out of service until the safety valve has been replaced.
- Switch off the compressor.
- Disconnect the compressor from the electrical power supply and protect against unexpected restart.
- Remove the cover of the switch box.
- Switch off the "Test Safety Valve" switch (pressure switch will be activated!).
- Mount the cover of the switch box.
- Connect the compressor to the electrical power supply.

The safety valve test is now completed.

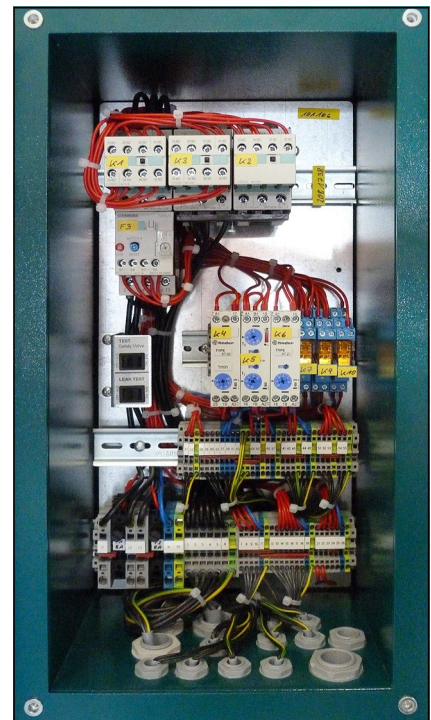

Switch box

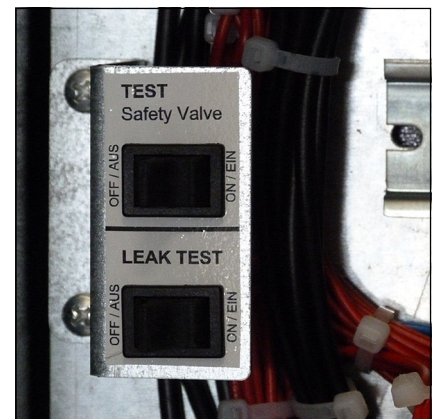

Safety valve test switch (up)

MAINTENANCE AND SERVICE

Leak test



Note

Do not fill any tank during test phase!

Leak test as follows:

- Disconnect the compressor from the electrical power supply and protect against unexpected restart.
- Remove the cover of the switch box.
- Switch on the leak test switch (solenoid valves will be deactivated!).
- Mount the cover of the switch box.
- Connect the compressor to the electrical power supply.
- Close filling valves.
- Start the compressor.
- Switch off the compressor at a pressure of approx. 150 bar.
- Verify the compressor for release noises. (A slight hiss of the air inlet filter nozzle can be ignored). If release noises occur, localise blow off position(s).
- Switch off the compressor.
- Disconnect the compressor from the electrical power supply and protect against unexpected restart.
- Remove the cover of the switch box.
- Switch off the leak test switch (solenoids will be activated!).
- Mount the cover of the switch box.
- Connect the compressor to the electrical power supply.

The leak test is now completed.



Switch box

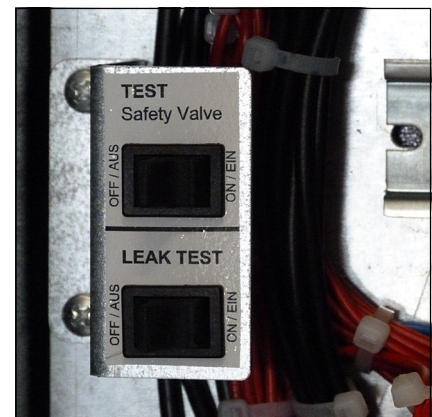

Leak test switch (lower)

MAINTENANCE AND SERVICE

Test of pressure equipment

According to the Pressure Equipment Directive (PED 97/23/EC) and TÜV Darmstadt (German supervising authorities). State: 10th of December, 2005

Subject: pressure equipment with a product permissible operating pressure [bar] x content volume [litres] from 200 up to 1000.

Example: Filter housing 1.7 l

Maximum operating pressure: 350 bar

Content volume: 1.7 litres

$350 \text{ bar} \times 1.7 \text{ litres} = 595$

595 is smaller than 1000 -> result: Test is applicable!!

Example: Filter housing 2.3 l

Maximum operating pressure: 350 bar

Content volume: 2.3 litres

$350 \text{ bar} \times 2.3 \text{ litres} = 805$

805 is smaller than 1000 -> result: Test is applicable!!

Pressure equipment from 200 up to 1000 have to be tested as follows:

1. Examination after 5 years by a qualified person or authorized organisations.

Visual inspection, inside and outside.

2. Examination after 10 years by a qualified person or authorized organisations.

Visual inspection, inside and outside.

In addition, a water pressure test is carried out at 1.5 times of the permissible vessel operating pressure.



A

MAINTENANCE RECORDS



A

STORAGE

STORAGE

Conservation / storage of the compressor

If the compressor unit is not to be used for an extended period of time, we recommend to carry out the following work before storage time:

- Run the compressor at 200 bar filling pressure for approximately ten minutes (control the flow with the filling valve to maintain constant pressure).
- Replace compressor oil, open filling valve(s) and run compressor for a few minutes.
- Stop compressor and open drain valves (depending on the compressor type, this may happens automatically). Remove top cap of final filter housing: clean throat, grease o-ring. and throat with a food grade grease or silicone grease. Close filter housing.
- Remove intake filter cartridge and undo intake pipes on all valve heads.
- Start compressor unit. Spray a few drops of compressor oil into intake connectors.
- Stop compressor unit and insert intake filter cartridge. Bring intake pipes back in position and fix connections and nuts. Close filling- and drain valves.
- Store the compressor in a cool dry place free from dust and contamination. A dust cover is recommended as long as condensation can be avoided.
- If compressor unit should be stored for a period of more than one year, an oil change is strongly recommended before it's been re-used.
- Fuel driven units only: fill up fuel tank to top level to avoid corrosion.

De-conservation, commissioning

After the compressor has been stored, the following steps are to be taken:

- If compressor hasn't been used for longer than 12 months, we strongly recommend an oil change before any use.
- Replace intake filter cartridge and check oil level.
- Clean compressor unit, check for foreign objects. Check condition and tension of V-belts, replace if necessary. Check condition of filling hoses, replace if necessary.
- Secure hoses against whipping and open filling valves and run compressor for approximately 10 minutes.
- Check condition of final filter cartridge, replace if necessary.
- Close filling valves and run compressor up to final pressure.
- Check safety valve relief pressure of final stage and/or pressure switch setting.
- Check all connections and pipe work for leaks.

Once all above steps are completed, compressor unit is now ready for use.

STORAGE

Transportation instructions

- Parts which need to be dismantled for transport purposes must be carefully replaced and secured before taking into operation.
- The transport may only be carried out by trained personnel.
- For transportation, only use lifting devices and equipment with sufficient lifting power.
- Do not stand or work under suspended loads.
- Also separate from minor relocation machinery / system of any external energy supply. Before recommissioning, reconnect the machine to the mains according to regulations.
- When recommissioning, proceed according to the operating instructions..

Disposal

The product must be disposed in accordance with national waste disposal regulations and by an appropriate waste disposal company.

Electric and electronic components

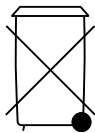

EU-wide regulations for the disposal of electric and electronic appliances which have been defined in the EU Directive 2002/96/EC and in national laws are effective from August 2005 and apply to this device.

Common household appliances can be disposed by using special collecting and recycling facilities. However, as this device has not been registered for household usage, it must not be disposed of through these means.

The device can be returned to L&W. Please do not hesitate to contact us if you have any further questions on this issue.

Operating Instructions

ECC - Electronic compressor control





TABLE OF CONTENTS

General Information

General Information	3
Description of Warning Symbols	3

Description

Specifications / Options	4
Switchboard	5

Operation and Function

Main Menu	6
Selection Menu (M100)	7
Display Menu (M200)	8
Inter-Stage Pressure Display.....	8
Display II (M270)	9
Settings Menu (M300).....	10
Set Stop Pressure - automatic mode (M320).....	11
Set Restart Pressure - automatic mode (M330).....	11
Set Stop Pressure - semi-automatic mode (M340)	11
Test Menu (M400)	12
Test Solenoids (M420)	12
Test safety valve (M430)	13
Test stop without venting (M440)	13
Statistics Menu (M500).....	14
Maintenance Menu (M600)	15
Confirm Maintenance (M680).....	16
Operation Mode (M700).....	17
Language Menu (M750)	17
Adjusting Display Backlight.....	18
Software Update	18
Spare part lists.....	19
Manufacturer in terms of 97/23/EC.....	20

B



GENERAL INFORMATION

General Information

We strongly recommend reading this manual thoroughly prior to operation and follow all the safety precautions precisely. Damage resulting from any deviation from these instructions is excluded from warranty and liability for this product. Carry out other commissioning steps only if you have fully understood the following contents.

Before commissioning and using the unit, carry out all the essential preliminary work and measures concerning legal regulations and safety. These are described on the following pages of this operation manual.

B

Description of marks and warning signs

The following warning signs are used in this document to identify the corresponding warning notes which require particular attention by the user. The warning signs are defined as follows:



Caution

Indicates an imminently hazardous situation which, if not avoided, could result in serious injury, physical injury or death.



Warning

Indicates a potentially hazardous situation which, if not avoided, could result in physical injury or damage to the product or environment.



Note

Indicates additional information on how to use the unit.



DESCRIPTION

Specifications and Options

All L&W compressors can be optionally equipped with the all-electrical computer supported control system "ECC". It is easy to operate and allows multiple and individual settings.

Specifications

- LCD-Display with key pad
- Automatic & semi-automatic operation mode
- Automatic dump system
- Integrated counter for operation hours
- Integrated counter for load cycles
- Maintenance intervals automatically displayed
- Required service part numbers automatically displayed
- Fully adjustable pressure ranges for start and stop
- Warning messages ("Housing Open" / "Emergency Switch")
- Check of end-pressure safety valve possible
- Auto switch-off when system is not running
- Extendable by additional modules (e.g. external filling panel)
- Easy to operate menu
- Door position switch (housing open message)
- Load-free or depressurised start cycles

Options

- Oil pressure control
- Oil temperature control
- Cylinder head temperature control
- Inter stage pressure monitoring
- PIN controlled access
- Master / slave option (if more than one ECC equipped compressors are combined)

DESCRIPTION

Switchboard



No.	Description
1	LCD Display
2	Key Pad
3	LED Display (Compressor OFF)
4	LED Display (Power)
5	LED Display (Compressor ON)



OPERATION AND FUNCTION

Main Menu

Immediately after the compressor has been connected to power, the ECC-display shows the following Main Menu::

Charging	0 min
Total	0,0 h
Start : 1	Stop : 0
Help: *	OFF
Final Press	0 bar

Present filling time in minutes

Total operation hours

Key 1 to start compressor / Key 0 to stop compressor

* Key leads to submenus Current operation state = Off

Present filling pressure

B

The following keys can now be used:

Key	Function / Description
1	Start - Starts the compressor
0	Stop - Stops the compressor
*	Leads to the submenus

After typing the * key the following Selection Menu appears.



OPERATION AND FUNCTION

Selection Menu (M100)

After typing the * key in the Main Menu the following Selection Menu appears.

Selection:		
2	Display	Key 2 leads to submenu "Display"
3	Settings	Key 3 leads to submenu "Settings"
4	Test	Key 4 leads to submenu "Test"
5	Statistics	Key 5 leads to submenu "Statistics"
6	Maintenance	Key 6 leads to submenu "Maintenance"
7	Operation Mode	Key 7 leads to submenu "Operation mode"
(M100)	Return : #	Key # leads back to "Main Menu"

(M100) tells that you are currently on menu page 100.



Note

At any time, the unit can be started with key 1 or shut down with key 0.
Caution: Risk of accident during maintenance work!

OPERATION AND FUNCTION

Display Menu (M200)

Pushing key 2 in the Selection Menu leads to Submenu "Display".

Display I:	
2	Press. Stage 1
3	Press. Stage 2
4	Press. Stage 3
5	Cyl. Head Temp.
6	Oil Temp.
7	Display II
(M200)	Return : #

Key 2 shows current pressure of the 1st stage*

Key 3 shows current pressure of the 2nd stage

Key 4 shows current pressure of the 3rd stage

Key 5 shows temperature of the final stage cylinder head

Key 6 shows the oil temperature

Key 7 shows Display II

Key # leads back to "Main Menu"

(M200) tells that you are currently on menu page 200.

By pushing key 2 (inter-stage pressure 1) the following Display appears.

Inter-Stage Pressure Display

Pushing key 2 in the Display Menu leads to the Inter-Stage Pressure 1 Display Menu.

Charging	0 min
Total	0,0 h
Start: 1	Stop: 0
Help:*	OFF
Press.	0 bar
1 st Stage	0,0 bar

Use keys 3 to 6 in the Menu "Display I" to change between the displayed values.



Note

Pushing key 8 in the display menu "Display II" leads to the option "Pressure200/300" for compressors with 2 filling pressures. Displayed in field 3 of the display menu "Display I".



OPERATION AND FUNCTION

Display II (M270)

Pushing key 7 in the Selection Menu leads to Menu "Display II".

Display II:

Press.	Temp.
4: 0	C: 0
5: 0	D: 0
6: 0	E: 0
7: 0	F: 0
bar	°C
(M270)	Return : #

This display shows further customer specific pressure and temperature values.

Key # leads back to "Main Menu"

B

OPERATION AND FUNCTION

Settings Menu (M300)

Pushing key 3 in the Selection Menu leads to the Settings Menu.

Settings:		
Automatic		
2	Stop pressure	Key 2 leads to submenu „Set Stop Pressure“
3	Restart Press.	Key 3 leads to submenu „Set Restart Pressure“
Semi-Automatic		
4	Stop Pressure	Key 4 leads to submenu „Set Stop Pressure“
9	Close	Key 9 leads back to submenu "Selection"
(M300)	Return : #	Key # leads back to "Main Menu"

Use menu M700 to change between "Automatic" and "Semi-Automatic" mode.

Restart pressure can only be set in "Automatic Mode".

Prior to setting the pressure, start the safety valve test.



Attention during maintenance

During automatic mode, the compressor can automatically start by itself at any time, depending on the selected restart pressure (see "Set Restart Pressure" M330).



OPERATION AND FUNCTION

Set Stop Pressure - automatic mode (M320)

Only valid in automatic mode, see menu M700.

Set
Stop Pressure:
Actual: 330 bar
7 New Value:
>> XXX bar
4 (050,, 333)
8 Confirm
(M320) Return : #

Current restart pressure
Key 7 if restart pressure should be changed
XXX indicates modified stop pressure
Chooseable pressure range for restart pressure
Key 8 confirms new restart pressure
Key # leads back to "Main Menu"

B

Set Restart Pressure - automatic mode (M330)

Only valid in automatic mode, see menu M700.

Set
Restart Pressure:
Actual: 180 bar
7 New Value:
>> XXX bar
4 (030,, 310)
8 Confirm
(M330) Return : #

Current restart pressure
Key 7 if restart pressure should be changed
XXX indicates modified restart pressure
Chooseable pressure range for restart pressure
Key 8 confirms new restart pressure
Key # leads back to "Main Menu"

Set Stop Pressure - semi-automatic mode (M340)

Only valid in semi-automatic mode, see menu M700.

Set
Stop Pressure:
Actual: 180 bar
7 New Value:
>> XXX bar
4 (030,, 310)
8 Confirm
(M340) Return : #

Current stop pressure
Key 7 if stop pressure should be changed
XXX indicates modified stop pressure
Chooseable pressure range for stop pressure
Key 8 confirms new restart pressure
Key # leads back to "Main Menu"

OPERATION AND FUNCTION

Test Menu (M400)

Pushing key 4 in the Selection Menu leads to the Test Menu.

Test:	
2	Solenoids
3	Safety Valve
4	Test-Stop
9	Close
(M400)	Return : #

Key 2 leads to submenu "Test Solenoids"

Key 3 leads to submenu "Test Safety Valve"

Key 4 leads to submenu "Test Stop without Venting"

Key 9 leads back to submenu "Selection"

Key # leads back to "Main Menu"

B

Test Solenoids (M420)

Pushing key 2 in the Selection Menu leads to Submenu "Test Solenoids".

Test Solenoids	
3	open
7	close
9	Close
(M420)	Return : #

Key 3 opens solenoids

Key 7 closes solenoids

Key 9 leads back to submenu „Test“

Key # leads back to "Main Menu"



Note

This menu can not be left unless solenoids have been closed by key 7.

OPERATION AND FUNCTION

Test safety valve (M430)

Pushing key 3 in the Test Menu leads to Submenu "Test Safety Valve".



Note

Prior to starting the Test, close all filling connections (also connected filling panels if necessary). During this test, the compressor passes the selected stop pressure (see Menu M320) to test the correct function of the final pressure safety valve. This would limit the maximum operating over pressure of the unit in case of malfunction.

B

Test
Safety Valve

Close Filling Valves!

5 Start	0 Stop
9 Close	
(M430) Return : #	

Key 5 to start test Key 0 to stop test

Key 9 leads back to submenu „Test“

Key # leads back to "Main Menu"

Test stop without venting (M440)

Pushing key 4 in the Test Menu leads to Menu "Test Stop without Venting".



Note

This test is only operable when the compressor has been started with key 1. This test mainly checks the leak tightness of pressure vessels, pressurised pipes, safety valves and the compressor block.

Test
stop without venting:

5 Stop	
6 Vent	
Pressure	0
	bar
9 Close	
(M440) Return : #	

Key 5 stops compressor during test run

Key 6 vents compressor after leak search has been finished

Shows current filling pressure

Key 9 leads back to submenu „Test“

Key # leads back to "Main Menu"



OPERATION AND FUNCTION

Statistics Menu (M500)

Pushing key 5 in the Selection Menu leads to Submenu "Statistics".

Statistics	
Operation Hours:	0,0 h
Start cycles:	00
Max Press	000 bar
9 Close	
(M500) Return : #	

Total operation hours of compressor unit

Total number of compressor starts

Maximum working pressure of unit (set by safety valve test)

Key 9 leads back to submenu „Selection“

Key # leads back to "Main Menu"

Push key 5 to get information on which ECC software version is currently installed on your system (M505), i.e.: By pushing key 2, the total load cycles of the filter housing are being indicated.

B

OPERATION AND FUNCTION

Maintenance Menu (M600)

Pushing key 6 in the Selection Menu leads to the "Maintenance Menu".

Hours remaining		
Oil change	14 h	Shows remaining hours of listed components (i.e. next oil change in 14 hours,...)
Sinter filt	989 h	
Silencer	4989 h	
Valves	5989 h	
Oil filter	1000 h	
8 Change done		Key 8 leads to submenu "Receipt Maintenance"
9 Close		Key 9 leads back to submenu „Selection“
(M600) Return : #		Key # leads back to "Main Menu"

Remaining hours depend on the type. At the end of any remaining hours, the display indicates a warning message. Furthermore, the display informs about any possibly necessary spare parts with the corresponding L&W service part number.



Attention during maintenance

During automatic mode, the compressor can automatically start by itself at any time, depending on the selected restart pressure (see "Set Restart Pressure" M330).



OPERATION AND FUNCTION

Confirm Maintenance (M680)

Confirm Maintenance	
2	Oil change
3	Sinter filters
4	Silencer
5	Valves
6	Oil filter
(M680)	Return : #

Key 2 receipts oil change
Key 3 receipts change of sinter filters
Key 4 receipts change of silencer
Key 5 receipts change of valves
Key 6 receipts oil filter
Key # leads back to "Main Menu"

B

Display confirms any reset of "Hours remaining" with the following message:

Confirm Maintenance	
Operation Hours Meter Set	
9	Close
(M680)	Return : #

Key 9 leads back to submenu "Hours remaining"
Key # leads back to "Main Menu"

OPERATION AND FUNCTION

Operation Mode (M700)

Pushing key 7 in the Selection Menu leads to the menu "Operation Mode".

Activated modes are always displayed in bolt letters (above example: **Semi-Automatic**).

Further settings can be made in the Settings Menu (M300).

B

Betriebsart:	
2	Automatic
3	Semi-Automatic
4	bar /mpa
5	Sprache
9	Close
(M700)	Return : #

Key 2 activates automatic mode

Key 3 activates semi-automatic mode

Key 4 selects between bar and MPa (optional)

Key 5 leads to the "Language Menu"

Key 9 leads back to submenu „Selection“

Key # leads back to "Main Menu"

Language Menu (M750)

Language Menu	
2	German
3	English
4	French
5	Spanish
6	Dutch
7	Language II
(M750)	Return : #

Key 7 optional language (e.g. Chinese)

Key # leads back to "Main Menu"

OPERATION AND FUNCTION

Adjusting Display Backlight

The brightness of the display can be adjusted with an adjusting screw on the back of the control.

Software Update

Software updates can only be carried out by L&W. To carry out an update, the device has to be send to the L&W service.



Adjust brightness

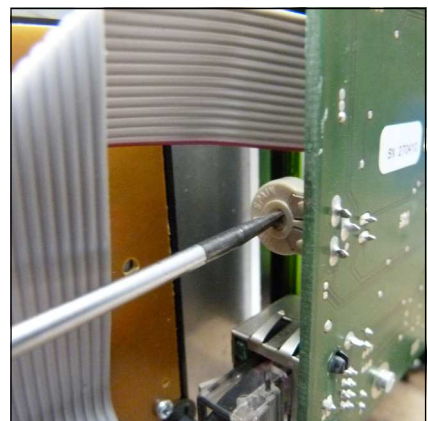

Adjust brightness



LENHARDT & WAGNER GMBH

B

Manufacturer in terms of 97/23/EC

The full name and address of the manufacturer is:

Lenhardt & Wagner GmbH

An der Tuchbleiche 39
68623 Hüttenfeld / Germany

Phone: +49 (0) 62 56 - 85 88 0 - 0

Fax: +49 (0) 62 56 - 85 88 0 - 14

E-Mail: service@lw-compressors.com

Internet: www.lw-compressors.com





ATTACHMENT

E

Lenhardt & Wagner GmbH

**An der Tuchbleiche 39
D-68623 Lampertheim – Hüttenfeld**

www.lw-compressors.com



Operating Instruction

Safety valve

Typ:

SiV2 BKZ 989 TÜV.SV.12-989.5.G.V.P CE 0091 AlMgSi1 F31 1100* Lenhardt & Wagner

SiV BKZ TÜV.SV.14-1140.5.G.V.p CE 0091 AlMgSi1 F31 1100* Lenhardt & Wagner

Set pressure:	see mark (hand wheel on top of valve)
Maximum outflow:	Set pressure 100-159 bar: 750 l / min Set pressure 160-350 bar: 1.100 l / min
Suitable media:	Media-resistant, non-corrosive gases

The safety valve is used for protection of pressurized components, eg pipelines, pressure vessels, or the compressor itself.

The hand wheel on the top of the safety valve is marked with the adjusted set pressure.



- 1) **Identification of set pressure**
- 2) **Seal**
- 3) **Fixing screws¹**
- 4) **Venting screw (hand wheel)**
- 5) **Identification serial number**
- 6) **Socket for safety valve**

Safety valve with socket

¹ und die Anforderungen des AD 2000 Merkblatts W7 erfüllen. The fixing screws M8 must be strength class 8.8 and meet the requirements of Merkblatt AD 2000 leaflet W7. Shaft length 70mm.

In order to prevent manipulation of the set pressure, all safety valves are factory fitted with a seal.

A safety valve on which the seal has been removed, must be returned to the manufacturer for repair / adjustment before further use.

In addition, the safety valve has a venting device (hand wheel).

When rotated clockwise, the safety valve and the filter housing of the final stage are completely vented.

During normal operation, the screw is unscrewed to the upper stop anticlockwise; an integrated safety ring prevents the screw from being removed.

If a safety valve blows off, the system must be switched off immediately and the cause of the error, investigated.

There are two possible reasons:

1. The safety valve is defective and blows off before the set pressure.

In this case the safety valve should be submitted immediately to the manufacturer for repair or replaced with a new one.

2. The safety valve opens properly, the problem is on the system.

A constant blowing of the safety valve is not permitted, the sealing seat of the valve can be damaged. The error on the system must be detected and repaired before further filling operations.

The safety valve may only be used if it is ensured that the maximum flowrate of the system does not exceed the blow-off rate of the safety valve.

The safety valve may only be used with the approved media.

Repair work on compressors must only be performed by trained personnel.

Dismantling of the safety valve

Ensure that on the safety valve is no pressure.

Loosen and remove the two M8 fixing bolts with a 6 mm Allen key.

The safety valve can now be removed by turning and simultaneously pulling out of the socket.

Mounting

1. Clean the safety valve socket.

2. Oil the insert pin of the safety valve including the O-ring with 1 to 2 drops of oil.

3. Press the safety valve pin complete into the socket.

4. Fasten the safety valve with the two 8 mm allen screws into the socket

(Tightening torque: 10 Nm)

5. Screw the venting screw (hand wheel) anticlockwise to its upper limit.

6. Start the System (Compressor), check installation for leaks and proper function.

Manufacturer: Lenhardt & Wagner GmbH
An der Tuchbleiche 39
D-68623 Lampertheim – Hüttenfeld

Contact: E-Mail: service@lw-compressors.com
Web: www.lw-compressors.com
Tel.: +49 (0) 6256 – 85880 0
Fax: +49 (0) 6256 – 85880 14

Note:

Only use safety valves which are in a technically perfect condition, for its intended purpose, safety and danger awareness, in compliance with the operating instructions!
Faults which could affect safety must be rectified immediately!

Notes:

- The safety valve must be installed directly on the protected pressure vessel and / or the plant.
 - The safety valve must be installed in an upright position.
 - The flow area of the port must be greater than the valve opening.
 - Protect valve against splashes
-

Maintenance:

- In accordance with current Pressure Equipment Directives, the safety valve must be periodically checked for operation and reliability.
- Refill annually lubricating oil:
Oil filling position:
Hole on the spacer (see arrow, Figure 1)
- Oil level: Fill oil into the hole until oil comes out of the hole.

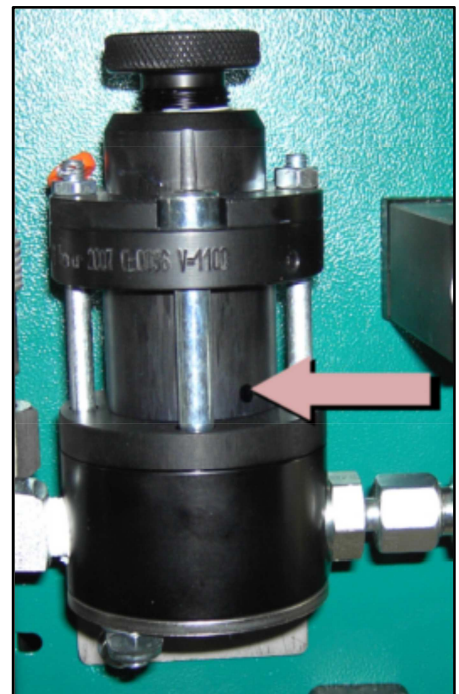

Figure 1: Position for oil refill

To be used lubricating oil for the safety valve: L&W Article N°.: 008500 (content: 30 ml)
